

Series 2260B

3-Year
Warranty

360W and 720W Programmable DC Power Supplies

- 360W and 720W versions with voltage up to 80V and current up to 72A
- Combine power supplies in serial and parallel combinations to expand voltage and current outputs up to 160V and 216A
- Programmable voltage or current rise and fall times from 0.1V/s to 160V/s or 0.01A/s to 144A/s prevent damage from inrush current to low impedance loads
- Constant current priority setting reduces voltage and current overshoot when powering LEDs
- Simulate a battery's output characteristics with a programmable output resistance
- Display delivered power with either the output current or the output voltage
- Choose from analog control, USB, LAN, or an optional GPIB interface for automated control
- Save bench and test system space: six 71mm-wide 360W units or three 143mm-wide 720W units fit in a standard rack width



Source a wide range of voltages and currents with the 360W Model 2260B-30-36 or the Model 2260B-80-13 Programmable DC Power Supplies. For higher power requirements, output up to 720W with either the Model 2260B-30-72 or the Model 2260B-80-27 DC power supplies. All four instruments have constant power outputs to provide a flexible range of voltage and current output combinations. The 360W supplies can output as much as 30V or 80V or as much as 13.5A or 36A, while the 720W supplies can output twice as much current, 72A and 27A, with the same maximum voltage outputs. The wide range of output voltages and currents of the Series 2260B power supplies along with multiple interfaces, enable their use in numerous applications including research and design, quality control, and production test.

Use Series and Parallel Combinations to Extend the Voltage Output to 160V and the Current to 216A

When more than 80V is needed, two Model 2260B power supplies can be connected in series to double the maximum output voltage to 160V. Similarly, up to three Model 2260Bs can be connected in parallel to produce as much as 216A. To combine the supplies in either series or parallel, they are controlled using a master-slave configuration. The power supply defined as the master unit will show the total voltage and current. Thus, multiple units used in combination can deliver up to 2160W to address numerous high power applications.

Control the Voltage or Current Rise Time to Reduce Inrush Current and Prevent Device Damage

To prevent potentially dangerous inrush currents from flowing into loads that have low resistance when power is initially supplied, the Series 2260B power supplies have programmable rise time (or slew rate) control. Either the voltage rise time or the current rise time can be controlled. With voltage slew rate control, the voltage rise time can range from a slow 0.1V/s to a high speed of 160V/s for the 80V models. When operating under constant current control, the output current rise time can be programmed from a low slew rate of 0.01A/s to a maximum value of 144A/s for the 2260B-30-72. The programming of a current rise time puts the Series 2260B supplies in a constant current control priority mode in which the current slew rate limits the rate at which the voltage rises across the device under test (DUT). In addition to controlling the rise time, the fall time can also be programmed; and the fall time values can be different from the rise time values. Thus, the delivery of power to a load can be precisely controlled to prevent overshoot spikes and excessive amounts of inrush current. This capability prevents damage to components, modules, or devices and will generate more precise characteristic I-V curves for components such as LEDs.

APPLICATIONS

- Environmental test, stress test, and accelerated life testing
- LED and high power component testing
- Automotive testing
- Battery research and test
- Production test

1.888.KEITHLEY (U.S. only)

www.keithley.com

KEITHLEY
A Tektronix Company

Programmable DC power supplies

DC POWER SUPPLIES

Series 2260B

360W and 720W Programmable DC Power Supplies

Ordering Information

2260B-30-36
Programmable DC 360W Power Supply, 30V, 36A

2260B-80-13
Programmable DC 360W Power Supply, 80V, 13.5A

2260B-30-72
Programmable DC 720W Power Supply, 30V, 72A

2260B-80-27
Programmable DC 720W Power Supply, 80V, 27A

Accessories Supplied

2260B Basic Accessories Kit (terminal mounting hardware and protective cover)

Test Leads

USB Cable

Quick Start Guide

CD with Manuals and Software Drivers

Power cord

ACCESSORIES AVAILABLE

2260-001	Accessory Kit
2260-002	Simple IDC Tool
2260-003	Contact Removal Tool
2260-004	Basic Accessories kit
2260-005	Cable for 2 units in Series connection
2260-006	Cable for 2 units in Parallel connection
2260B-007	Cable for 3 units in Parallel connection
2260B-GPIB-USB	GPIB-to-USB Adapter
2260B-EXTERM	Extended Terminal
2260B-RMK-JIS	Rack Mount Kit (JIS racks)
2260B-RMK-EIA	Rack Mount Kit (EIA racks)

SERVICES AVAILABLE

Model Number*-EW	3-year factory warranty extended to 1 additional year from date of shipment
Model Number*-5Y-EW	3-year factory warranty extended to 5 years from date of shipment
C/Model Number*-3Y-STD	KeithleyCare 3 Year Standard Calibration Plan
C/Model Number*-3Y-DAT	KeithleyCare 3 Year Calibration with Data Plan
C/Model Number*-5Y-STD	KeithleyCare 5 Year Standard Calibration Plan
C/Model Number*-5Y-DAT	KeithleyCare 5 Year Calibration with Data Plan

*Insert Model Number. Examples: 2260B-30-36-5Y-EW, C/2260B-80-27-3Y-DAT

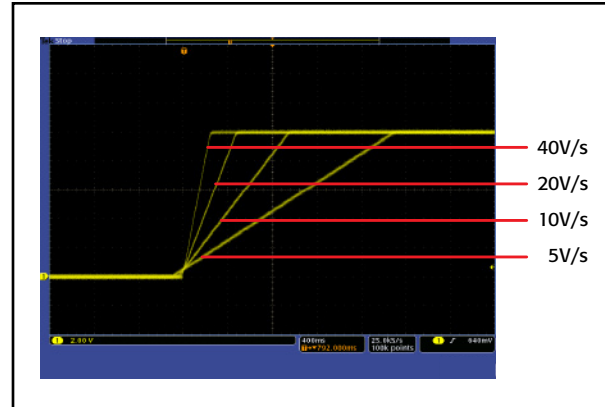

Precisely control voltage rise time with the variable slew rate control.

Emulate the Response of a Battery

Test a circuit or device under the most realistic conditions by applying a test source with the output resistance that is equivalent to the output resistance of the actual source that will be used to power the circuit or device. For example, a battery has a varying internal resistance, and a device powered by a battery will have a voltage applied to the device that is reduced by the voltage drop across the battery's internal resistance. Versions of the Series 2260B supplies can have an internal resistance up to 59Ω to simulate devices such as a lead-acid battery.

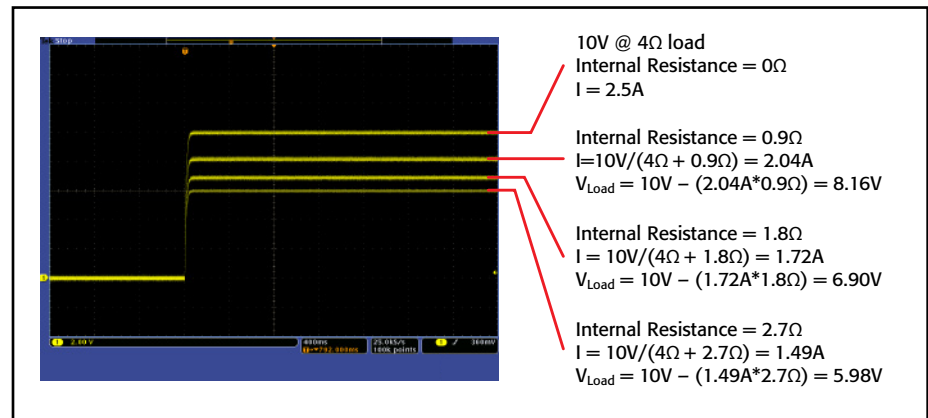

Use the programmable internal resistance to simulate a battery's output. In this example, a Model 2260B-80-13 power supply is simulating a 10V battery whose internal resistance is 0Ω, 0.9Ω, 1.8Ω, and 2.7Ω. The resulting voltage at the output terminals drops from 10V to 5.98V due to the voltage drop across the internal resistance of the battery.

Create Custom Voltage Source Waveforms

An internal test sequence mode allows the Series 2260B supplies to output a set of voltage levels for varying time intervals at each level. The test sequence can be stored and used repeatedly to determine DUT performance at number of voltage levels. In addition, the analog input control can be used to create voltage profiles that simulate how a battery responds to a fast changing load current requirement such as a large inrush current. Also, generate a combined DC output level with an AC signal superimposed on it to test how a circuit responds to noise on its DC power source. The analog input control parameter can be either a voltage input or a resistance input. With this analog control capability, numerous types of DC supply signals can be generated to test circuits and devices under a wide range of circumstances.

1.888.KEITHLEY (U.S. only)

www.keithley.com

Series 2260B

360W and 720W Programmable DC Power Supplies

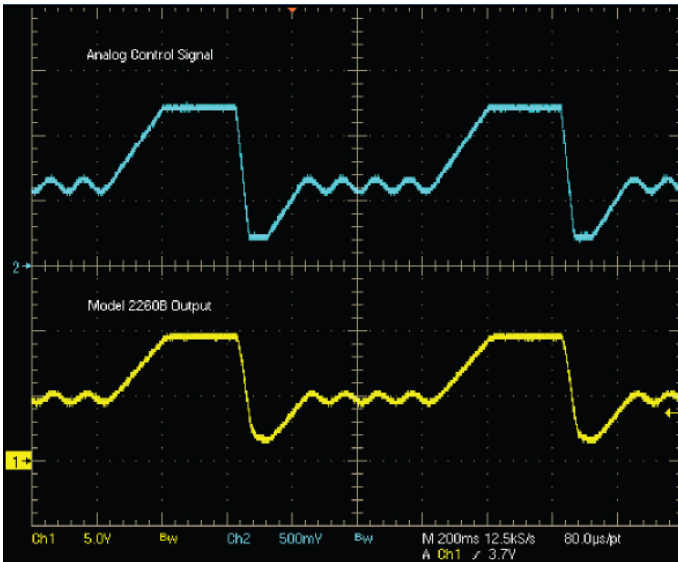

A signal generator (top plot) controls the 2260B to create a complex DC supply waveform (bottom plot) that simulates both a voltage drop due to a large inrush current and noise on the DC supply line.

Flexible and Fast for Automated Test Systems

The Series 2260B power supplies will work in any automated system because they can interface to a controller with either a USB, LAN, or optional GPIB interface. Furthermore, the Series 2260B supplies have fast discharge capability to dissipate the voltage on the output quickly. These supplies also have a fast (1ms) transient recovery time to load changes. The combination of the fast discharge time and the fast transient response helps minimize critical test time in automated test systems.



Rear panel of 360W models.



Rear panel of 720 models.

1.888.KEITHLEY (U.S. only)

www.keithley.com

KEITHLEY
A Tektronix Company

Series 2260B

360W and 720W Programmable DC Power Supplies

Specifications (23°C ±5°C)

	2260B-30-36	2260B-30-72	2260B-80-13	2260B-80-27
OUTPUT RATING				
Voltage	0–30 V	0–30 V	0–80 V	0–80 V
Current	0–36 A	0–72 A	0–13.5 A	0–27 A
Power	360 W	720 W	360 W	720 W
RIPPLE AND NOISE (Noise bandwidth 20 MHz, ripple bandwidth 1 MHz)				
CV p-p	60 mV	80 mV	60 mV	80 mV
CV rms	7 mV	11 mV	7 mV	11 mV
CC rms	72 mA	144 mA	27 mA	54 mA
PROGRAMMING ACCURACY				
Voltage	0.1% + 10 mV	0.1% + 10 mV	0.1% + 10 mV	0.1% + 10 mV
Current	0.1% + 30 mA	0.1% + 60 mA	0.1% + 10 mA	0.1% + 30 mA
READBACK ACCURACY				
Voltage	0.1% + 10 mV	0.1% + 10 mV	0.1% + 10 mV	0.1% + 10 mV
Current	0.1% + 30 mA	0.1% + 60 mA	0.1% + 10 mA	0.1% + 30 mA
RESPONSE TIME				
Rise Time	50 ms	50 ms	50 ms	50 ms
Fall Time (full load)	50 ms	50 ms	50 ms	50 ms
Fall Time (no load)	500 ms	500 ms	500 ms	500 ms
Load Transient Recovery Time (load change from 50 to 100%)	1 ms	1 ms	1 ms	1 ms
PROGRAMMING RESOLUTION (by PC Remote Control Mode)				
Voltage	1 mV	1 mV	2 mV	2 mV
Current	1 mA	2 mA	1 mA	2 mA
MEASUREMENT RESOLUTION (by PC Remote Control Mode)				
Voltage	1 mV	1 mV	2 mV	2 mV
Current	1 mA	2 mA	1 mA	2 mA
FRONT PANEL DISPLAY ACCURACY				
Voltage	0.1% + 2 counts	0.1% + 2 counts	0.1% + 2 counts	0.1% + 2 counts
Current	0.1% + 4 counts	0.1% + 7 counts	0.1% + 2 counts	0.1% + 4 counts

REGULATION (CV):

Load: 0.05% of setting + 5mV. Line: 0.05% of setting + 3mV.

REGULATION (CC):

Load: 0.1% of setting + 5mA. Line: 0.1% of setting + 5mA.

VOLTAGE SLEW RATE RANGE: Rising and Falling:

0.1V/s to 60V/s (2260B-30-36, 2260B-30-72).

0.1V/s to 160V/s (2260B-80-13, 2260B-80-27).

CURRENT SLEW RATE RANGE: Rising and Falling:

0.01A/s to 72A/s (2260B-30-36)

0.01A/s to 144A/s (2260B-30-72)

0.01A/s to 27A/s (2260B-80-13)

0.01A/s to 54A/s (2260B-80-27).

REMOTE SENSE: 0.6V total voltage drop in load wires.

OUTPUT DELAY TIME RANGE:

On Delay and Off Delay: 0s to 9999s.

INTERNAL RESISTANCE RANGE:

0.000Ω to 0.833Ω (2260B-30-36)

0.000Ω to 0.417Ω (2260B-30-72)

0.000Ω to 5.926Ω (2260B-80-13)

0.000Ω to 2.963Ω (2260B-80-27).

SERIES AND PARALLEL CAPABILITY:

Parallel Operation: Up to 3 units including the master unit.

Series Operation: Up to 2 units including the master unit.

PROTECTION FUNCTION:

OVP: 10% to 110% of rated output voltage range.

Accuracy: ±2% of rated output voltage.

OTP: 10% to 110% of rated output current range.

Accuracy: ±2% of rated output current.

OTP: Activated by elevated internal temperatures.

ISOLATION VOLTAGE: 500VDC, output to chassis.

ANALOG VOLTAGE CONTROL:

Voltage Setting Accuracy: ±0.5% of rated output voltage.

Current Setting Accuracy: ±1% of rated output current.

ANALOG RESISTANCE CONTROL:

Voltage Setting Accuracy: ±1.5% of rated output voltage.

Current Setting Accuracy: ±1.5% of rated output current.

GENERAL

ANALOG CONTROL: External voltage or resistance control of output, voltage and current monitor outputs, turn-on, turn-off control, status monitoring, 26-Pin Connector (Rear Panel).

INTERFACE:

USB: 1.1/2.0, Type A Host (Front Panel), Type B Control (Rear Panel).

LAN: 100BASE-T (100Mb/s).

GPIB: (with optional 2260B-GPIB-USB Adapter).

AC INPUT RANGE: 85VAC-265VAC, 50/60Hz, single phase

MAXIMUM POWER CONSUMPTION:

500VA (2260B-30-36, 2260B-80-13)

1000VA (2260B-30-72, 2260B-80-27).

POWER FACTOR: 0.98 (typical).

FAN: With thermal sensing control

ENVIRONMENT:

Operating: 0° to 50°C, 20% to 85% RH.

Storage: –25° to 70°C, 90% RH or less.

TEMPERATURE COEFFICIENT (after 30 minutes warm-up):

Voltage: 100ppm/°C.

Current: 200ppm/°C.

SAFETY: Complies with European Union Low Voltage Directive.

ELECTROMAGNETIC COMPATIBILITY: Complies with European Union EMC Directive.

DIMENSIONS, WEIGHT:

2260B-30-36 and 2260B-80-13: 71mm wide × 124mm high × 350mm deep (2.80 in. × 4.88 in. × 13.78 in.).

Net Weight: Approx. 3kg (6.6 lb.) **Shipping Weight:** 4.3kg (9.5 lb.).

2260B-30-72 and 2260B-80-27: 142.5mm wide × 124mm high × 350mm deep (5.61 in. × 4.88 in. × 13.78 in.). **Net Weight:** Approx. 5kg (11 lb.) **Shipping Weight:** 6.8kg (15 lb.).

WARRANTY: 3 years.

1.888.KEITHLEY (U.S. only)

www.keithley.com

KEITHLEY
A Tektronix Company

Series 2260B

360W and 720W Programmable DC Power Supplies

Series 2260B Accessories



Model 2260-001: Accessory Kit: Analog control mating connector, pins, cover, and ground wire.



Model 2260-002: Simple IDC tool.

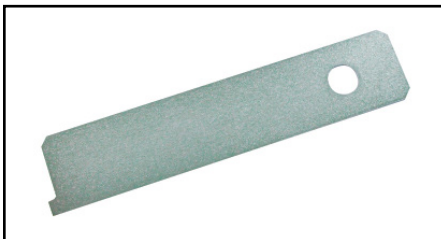

Model 2260-003: Contact removal tool.



Model 2260-004 Accessory Kit: Air filter, analog connector cover, analog control lock lever, M8-size output terminal bolts, washers and screws, and M4-size output terminal screws with washers.



Model 2260-005: Cable, 0.5m (1.6 ft.), to connect two series 2600B power supplies in series.



Model 2260-006: Cable, 0.5m (1.6 ft.), to connect two series 2600B power supplies in parallel.

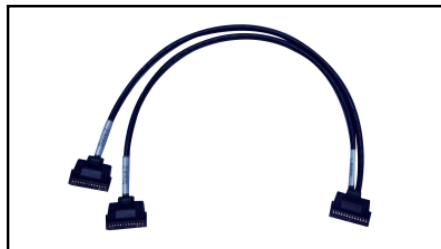

Model 2260-007: Cable, 0.5m (1.6 ft.), to connect three series 2600B power supplies in parallel.



Model 2260B-GPIB-USB Adapter: Provides a GPIB interface for the Series 2260B power supplies.



Model 2260B-EXTERM: Extended terminal; Test Leads, 0.7m (28 in.), and terminal box to bring outputs to the front of the instrument or another location. Magnetic base attaches to side of instrument.

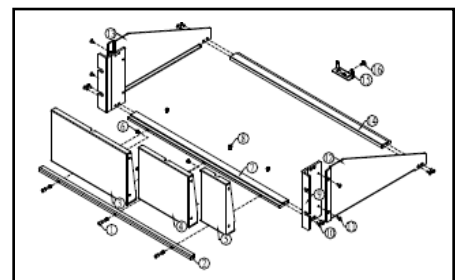

Model 2260B-RMK-EIA: Rack mount kit (EIA racks).

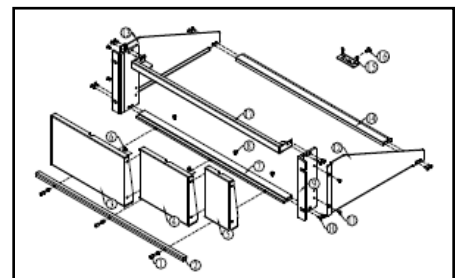

Model 2260B-RMK-JIS: Rack mount kit (JIS racks).

1.888.KEITHLEY (U.S. only)

www.keithley.com

KEITHLEY
A Tektronix Company

Specifications are subject to change without notice. All Keithley trademarks and trade names are the property of Keithley Instruments.
All other trademarks and trade names are the property of their respective companies.



A Greater Measure of Confidence

KEITHLEY INSTRUMENTS ■ 28775 AURORA RD. ■ CLEVELAND, OH 44139-1891 ■ 440-248-0400 ■ Fax: 440-248-6168 ■ 1-888-KEITHLEY ■ www.keithley.com

BENELUX

+31-40-267-5506
www.keithley.nl

FRANCE

+33-01-69-86-83-60
www.keithley.fr

ITALY

+39-049-762-3950
www.keithley.it

MALAYSIA

60-4-643-9679
www.keithley.com

SINGAPORE

01-800-8255-2835
www.keithley.com.sg

BRAZIL

55-11-4058-0229
www.keithley.com

GERMANY

+49-89-84-93-07-40
www.keithley.de

JAPAN

81-120-441-046
www.keithley.jp

MEXICO

52-55-5424-7907
www.keithley.com

TAIWAN

886-3-572-9077
www.keithley.com.tw

CHINA

86-10-8447-5556
www.keithley.com.cn

INDIA

080-30792600
www.keithley.in

KOREA

82-2-6917-5000
www.keithley.co.kr

RUSSIA

+7-495-664-7564
www.keithley.ru

UNITED KINGDOM

+44-1344-39-2450
www.keithley.co.uk

For further information on how to purchase or to locate a sales partner please visit www.keithley.com/buy