



8500 Series

Programmable AC Power Source

Operation Manual for Models

8505, 8512, 8520, 8540

V1.04

Part # 40237

August 2022



DECLARATION OF CONFORMITY



Manufacturer: Associated Power Technologies, An Ikonix Brand

Address: 28105 N Keith Drive
Lake Forest, IL 60045

Product Name: APT 8500 Series Power Source

Model Number: 8505, 8512, 8520 & 8540

Conforms to the following Standards:

Safety: EN 61010-1:2010+A1:2019

EMC: EN 61326-1:2013 Class A, IEC 61000-3-11:2000, IEC 61000-3-12:2011, EN 61326-2-1:2013, IEC 61000-4-2:2009, IEC 61000-4-3:2006+A2:2010, IEC 61000-4-4:2012, IEC 61000-4-5:2014 + A1:2017, IEC 61000-4-6:2014, IEC 61000-4-8:2010, IEC 61000-4-34:2007+A1:2009, EN55011:2016/A1:2017 (Group 1, Class A)

Supplementary Information

The product herewith complies with the requirements of the Low Voltage Directive 2014/35/EU, the EMC Directive 2014/30/EU and the RoHS Directive 2015/863/EU with respect to the following substances: Lead (Pb), Mercury (Hg), Cadmium (Cd), Hexavalent chromium (Cr (VI)), Polybrominated biphenyls (PBB), Polybrominated diphenyl ethers (PBDE), Deca-BDE, Bis(2-ethylhexyl) phthalate, Dibutyl phthalate, Benzyl butyl phthalate and Diisobutyl phthalate included.

Last two digits of the year in which the CE marking was affixed: 13

The technical file and other documentation are on file with Associated Power Technologies, Inc.

Joseph Guerriero
President
Associated Power Technologies, An Ikonix Brand
Lake Forest, Illinois USA
September 1, 2020

Table of Contents

This manual is an interactive PDF. Click each heading below to jump directly to the topic you need. Web addresses are also interactive.

1. Introduction	1-4
1.1 Warranty	1
1.2 Glossary	2-3
1.3 Safety Symbols	3-4
1.4 Safety Precaution	4
1.5 Service and Maintenance	4
2. Getting Started	5-8
2.1 Unpacking and Inspection	5
2.2 Input Current Consideration	5
2.3 Preparation For Use	5
2.4 Instrument Power Switch	6
2.5 Power Cable	6
2.6 Environmental Conditions	7
2.7 Packaging	8
3. Specifications and Controls	8-19
3.1 Specifications	8-15
3.2 Output Power, Power Factor and Output Current Considerations	15-16
3.3 Instrument Controls	16-19
4. Programming Instructions	20-43
4.1 Powering on the Instrument	20-21
4.2 System	21-23
4.3 Editing System Parameters	23-24
4.4 Mode and File	24-40
4.5 Edit, Copy, Delete, and Load Test File	41-43
5. Perform Test	44-52
5.1 Meter	44
5.2 Manual Mode	44
5.3 List Mode	45
5.4 Step Mode	45
5.4 Pulse Mode	45
5.6 Results	46
5.7 Perform Test Screen Considerations	47
5.8 Error and Failure Messages	48-52
6. Remote PLC	53-55
7. Bus Remote Interface USB/LAN/GPIB (Programmable Option Only)	56-78
7.1 USB Communication Port Configuration	56
7.2 LAN Configuration	57
7.3 SCPI (Standard Commands for Programmable Instruments) Basics	57-58
7.4 SCPI Command TREE	59-69
7.5 GPIB Interface	70-71
7.6 GPIB/USB/LAN Interface Sample Command List	72-78

8 Options	79
8.1 Option 01 – Programmable	79
8.2 Option 03 – GPIB Interface	79
9. Calibration Procedure	80-87
9.1 Enter Calibration Screen	80-81
9.2 Calibration of Voltage Setting and Measurement (Low Range)	81-84
9.3 Calibration of Voltage Setting and Measurement (High Range)	84
9.4 Calibration of Current Measurement	85-86
9.5 View Calibration Data	87
10. Service and Maintenance	88
11. Replacement Parts List	89-90

1. Introduction

1.1 Warranty

Ikonix, certifies that the power source listed in this manual meets or exceeds published manufacturing specifications. This power source was calibrated using standards that are traceable to the National Institute of Standards and Technology (NIST).

Your new power source is warranted to be free from defects in workmanship and material for a period of (5) years from date of shipment. We aim to provide an amazing experience and quality power sources that last a long time. If you're not satisfied with your power source, return it within 45 days for a full refund. Calibrate annually with us, or one of our authorized partners, and we'll extend your warranty an additional year for the service life of your power source, and at least five years after discontinuation. If it breaks during that time, we promise to fix it for free (unless abuse or excessive damage is present). When your power source reaches the end of its service life, we'll responsibly recycle it and give you a discount on a replacement. Annual calibration and inspection must be made in each successive year starting one year after the original purchase date in order to remain eligible for extended warranty coverage beyond the standard warranty period (five years).

Ikonix recommends that your power source be calibrated on a twelve-month cycle. A return material authorization (RMA) must be obtained from Ikonix. To obtain an RMA please contact our Customer Support team at 1-847-367-4378 or visit aptsources.com. Damages sustained as a result of improper packaging will not be honored. Transportation costs for the return of the power source for warranty service must be prepaid by the customer. Ikonix will assume the return freight costs when returning the power source to the customer. The return method will be at the discretion of Ikonix.

Except as provided, herein Ikonix makes no warranties to the purchaser of this power source and all other warranties, expressed or implied (including, without limitation, merchantability or fitness for a particular purpose), are hereby excluded, disclaimed and waived.

Any non-authorized modifications, tampering or physical damage will void your warranty. Elimination of any connections in the earth grounding system or bypassing any safety systems will void this warranty. This warranty does not cover accessories not of Ikonix manufacture. Parts used must be parts that are recommended by Ikonix as an acceptable specified part. Use of non-authorized parts in the repair of this power source will void the warranty.

*5 year warranty is valid on any model purchased in 2021 or after.

1.2 Glossary of Terms

- Alternating Current (AC)** - Current that reverses direction on a regular basis (usually 60 times per second in the United States). Measured in amps.
- AC Power Source** - An instrument that takes one AC voltage and frequency level and converts it into another AC voltage and frequency level.
- Amplifier** - A circuit that boosts an input signal from one level to another.
- Apparent Power** - The total power generated or consumed by a device due to real and reactive circuit components. Measured in VA (volt-amps).
- Crest Factor** - The ratio of peak current (A_{peak}) to RMS current (A_{rms}).
- Complex Power** – the vector sum of the real and reactive power components of a circuit. Measured in VA (volt-amps).
- Direct Current (DC)** - Current that only flows in one direction. Direct current comes from a polarized source, meaning one terminal is always at a higher potential than the other. Measured in amps.
- Frequency** - The number of times a waveform completes a cycle in a period of time. Measured in hertz.
- Inrush Current** - A term used to describe the current needed to power a load upon start-up. Some loads require a large/ inrush starting current in order to operate.
- Linear Power Source** – a power source that linearly amplifies the input signal using transistors to increase the voltage, current, and power output of the system.
- OC Fold** - Over current fold back is a technology used in power sources that keeps output current constant by reducing the voltage in order to power loads that may have a high inrush current.
- Phase Angle** – The degree of measurement that corresponds to an AC waveform's amplitude. Measured from 0 – 360 degrees.
- PLC** - Programmable Logic Control is an automation method using relay or digital technology.
- Power** - A generic term used to describe electrical work being done. There are many types of power, including real power, reactive power, apparent power, and complex power.
- Power factor** - The ratio of real power (watts) to apparent power (VA). Based on a scale from 0 to 1 to determine how reactive and resistive a load is.
- Reactive Power** – The power absorbed by capacitive or inductive elements in a circuit. This power does no work. Measured in VAR (volt-amps reactive).
- Real Power** – The power that performs work in a circuit. Measured in watts.
- Response Time** - The time that is needed to regulate the voltage, current, frequency, and power output when a load is added to the power source.

Safety Agency Listing - A safety mark given to a product that has met stringent benchmarks as classified by the authorized agency.

Steady State Current - A term used to describe the current when the load is running nominally after the inrush current.

Switching Power Source - A power source that uses switching technology (integrated circuits and components) in order to generate the AC voltage, current, frequency, and power.

Total Harmonic Distortion (THD) - A percentage that is used to identify the degree of the noise/unclean signal in a power source's output waveform.

Voltage - The amount of force that is needed to move current from point to point. Measured in volts.

1.3 Safety Symbols

1.3.1 Product Marking Symbols



Product will be marked with this symbol when it is necessary to refer to the operation and service manual in order to prevent injury or equipment damage.

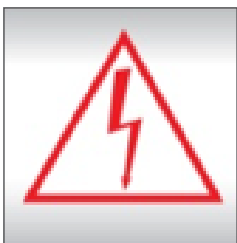

Product will be marked with this symbol when hazardous voltages may be present.



Product will be marked with this symbol at connections that require earth grounding.

1.3.2 Caution and Warning Symbols

WARNING

Calls attention to a procedure, practice, or condition that could possibly cause bodily injury or death.

CAUTION

Calls attention to a procedure, practice, or condition that could possibly cause damage to equipment or permanent loss of data.

1.4 Safety Precautions

This product and its related documentation must be reviewed for familiarization with safety markings and instructions before operation. Before applying power, verify that the instrument is set to the correct line voltage and the correct fuse is installed.

WARNING

Calls attention to a procedure, practice, or condition that could possibly cause bodily injury or death.

1.5 Service and Maintenance

User Service

To prevent electric shock do not remove the instrument cover. There are no user serviceable parts inside. Routine maintenance or cleaning of internal parts is not necessary. Any external cleaning should be done with a clean dry or slightly damp cloth. Avoid the use of cleaning agents or chemicals to prevent any foreign liquid from entering the cabinet through ventilation holes or damaging controls and switches, also some chemicals may damage plastic parts or lettering. Any replacement cables and high voltage components should be acquired directly from APT or its distributors.

Service Interval

The instrument must be returned at least once a year to an APT authorized service center for calibration and inspection of safety related components. APT will not be held liable for injuries suffered if the instrument is not properly maintained and safety checked annually.

User Modifications

Unauthorized user modifications will void your warranty. APT will not be responsible for any injuries sustained due to unauthorized equipment modifications or use of parts not specified by APT. Instruments returned to APT with unsafe modifications will be returned to their original operating condition at the customer's expense.

2. Getting Started

This section contains information for the unpacking, inspection, preparation for use, and storage of your APT product.

2.1 Unpacking and Inspection

Your instrument was shipped in a protective shipping carton designed to protect the instrument through the shipping process. If the shipping carton is damaged, inspect the contents for visible damage such as dents, scratches, or broken display. If the instrument is damaged, notify the carrier and APT's customer support department. Please save the shipping carton and packing material for the carrier's inspection. Our customer support department will assist you in the repair or replacement of your instrument. Please do not return your product without first notifying us.

Safe Lifting and Carrying Instructions

Proper methods of lifting and carrying can help to protect against injury. Follow the recommendations below to ensure that instruments are handled in a safe manner.

- Determine if the instrument can be lifted by one individual or requires additional support.
- Make sure that your balance is centered and your feet are properly spaced, shoulder width apart behind the instrument.
- Bend at the knees and make sure your back is straight.
- Grip the instrument with your fingers and palms and do not lift unless your back is straight.
- Lift up with your legs, not your back.
- Keep the instrument close to your body while carrying.
- Lower the instrument by bending your knees. Keep your back straight.

2.2 Input Current Considerations

Models	8505	8512	8520	8540
Input Voltage	100 - 240 V \pm 10%			200 - 240 V \pm 10%
Input Current Max	8A	18A	30A	30A

2.3 Preparation For Use

This instrument requires a power source of 100 – 240V AC \pm 10%, (47 – 63Hz) single phase for models 8505, 8512, and 8520. Model 8540 requires a 200 – 240V AC \pm 10%, (47 – 63Hz) balanced/single phase input source. Please read the sticker on the rear panel of the instrument to be sure the proper input voltage is provided before powering your instrument ON.

2.4 Instrument Power Switch

The power switch that is included in the instrument is not considered a disconnecting device. It only disconnects one current carrying conductor to power off the device. The user should configure the equipment with an external switch or circuit breaker for disconnecting it from each operating energy supply source. In compliance with EN61010-1 for permanently connected equipment this switch should meet the following guidelines.

- a. It shall be included in the building installation.
- b. It shall be in close proximity to the equipment and within easy reach of the operator.
- c. It shall be marked as the disconnecting device for the equipment.
- d. It shall not interrupt the protective earth conductor.
- e. It shall be in compliance with EN 60947 series, the rated voltage shall be at least equal to the rated input voltage of the equipment and the rated current shall be equal to the rated input current of the equipment.

WARNING

Be sure to select the appropriate wire gauge for use with the APT 8500 AC power source. The line cord and all applicable fixturing must be capable of handling the output current produced by the AC power source.

2.5 Power Cable

WARNING

Before connecting power to this instrument, the protective ground (earth) terminals of this instrument must be connected to the protective conductor of the line (mains) power cord. The main plug shall only be inserted in a socket outlet (receptacle) provided with a protective ground (earth) contact. This protective ground (earth) must not be defeated by the use of an extension cord without a protective conductor (grounding).

WARNING

The mains plug is used as the disconnecting device and shall remain readily operable. The socket-outlet shall be installed near the equipment and shall be easily accessible.

WARNING

The main plug shall only be inserted in a socket outlet with a protective ground (earth) contact. This protective ground must not be defeated by the use of an extension cord without a protective conductor.

CAUTION

Model 8505 - Do not replace the power supply cord with an improperly rated cord. For North American: A UL listed and CSA labeled power cord must be used with the instrument in the United States and Canada. The power cord must include a NEMA5-15 style male plug, SVT or SJT cord sets, and be rated for at least 125VAC, 10A, number 16 gauge (or 125VAC, 15A, number 14 gauge) wire or larger, and the length of the cord does not exceed 2 m must be used. For European: A certified power supply cord not lighter than light PVC

sheathed flexible cord according to IEC 60227, designation H03 VV-F or H03 VVH2-F (for equipment mass not exceeding 3 kg), or H05 VV-F or H05 VVH2-F2 (for equipment mass exceeding 3 kg), and be rated for at least 3G 0.75 mm² (for rated current up to 10 A) or 3G 1.0mm² (for rated current over 10 A up to 16 A) wire or larger, and the length of the cord does not exceed 2 m must be used.

The following chart lists the wire configuration that must be used for connection to the input and output of the different models:

Model	Input	Output
8512	12 AWG / 2.5mm ²	14 AWG / 1.5 mm ²
8520	10 AWG / 4mm ²	12 AWG / 2.5 mm ²
8540	10 AWG / 4 mm ²	8 AWG / 6 mm ²

CAUTION

The rear panel terminal covers should be used to prevent electric shock. The input/output terminals must be covered when using this product.

2.6 Environmental Conditions

Operating Environment (for indoor use)

Temperatures: 0° - 40° C (32° - 104° F)

Relative humidity: 20% - 80%

Altitude: 2,000 meters (6,562 feet)

Over Voltage Category: OVC II

Pollution Degree: PD2

WARNING

Do not block any ventilation openings to prevent overheating of the equipment. Keep the ventilation slits uncovered during operation. Failure to do so could cause the instrument to overheat and may damage internal components.

The instrument should also be protected against temperature extremes which may cause condensation within the instrument. If the instrument is used in a matter not specified by the manufacturer, the protection provided by the instrument may be impaired. The instrument should also be protected against temperature extremes which may cause condensation within the instrument.

Storage and Shipping Environment

This instrument may be stored or shipped in environments with the following limits:

Temperature.....-40° to +55° C

Altitude.....7,620 meters (25,000 feet)

2.7 Packaging

Please enclose the instrument with all options, accessories and test leads. All returns must be accompanied by a return material authorization (RMA) number which is provided by our customer support department. Failure to ship your instrument without an RMA number will result in additional fees for handling and storage.

APT will not be responsible for any repair costs associated with shipping damage as a result of improper packaging. The customer is responsible for providing adequate shipping insurance coverage while shipping an instrument in the event of loss or damage while in transit.

3. Specifications and Controls

3.1 Specifications

Models		8505	8512	8520	8540	
Input						
Phase		1Ø2W				
Voltage		100 - 240 V ± 10%			200 - 240 V ± 10%	
Max. Current		8A	18A	30A	30A	
Power Factor (* 1)		≥0.93 at Full load		≥0.97 at Full load		
Frequency		47 - 63 Hz				
AC Output						
Power Rating	1Ø2W	500VA	1250VA	2000VA	4000VA	
Max. Current (r.m.s) (* 2)	1Ø2W	0 - 155V	5A @ 100V	12.5A @ 100V	20A @ 100V	40A @ 100V
		0 - 310V	2.5A @ 200V	6.25A @ 200V	10A @ 200V	20A @ 200V
Inrush Current (peak) (* 3)	1Ø2W	0 - 155V	20A	50A	80A	160A
		0 - 310V	10A	25A	40A	80A
Frequency		5.0 - 1200 Hz				
Phase		1Ø2W				
THD (Total Harmonic Distortion) (* 4)		≤0.3% @ 50/60Hz (Full Resistive Load) ≤1.1% @ 5 - 1000Hz (Full Resistive Load) ≤1.2% @ 1001 - 1200Hz (Full Resistive Load)				
Crest Factor		≥3				
Line Regulation		±0.1V				
Load Regulation (Hardware) (* 5)		± (1% of output + 0.5V) @ Resistive Load, < 400µS response time				
Load Regulation (Software) (* 5)		±0.2V, < 1S response time				
DC Offset		≤±30mV (typical)				

Models			8505	8512	8520	8540
DC Output						
Power Rating			300W	750W	1200W	2400W
Max. Current (*2)	0 - 210V		3.0A	7.5A	12.0A	24.0A
	0 - 420V		1.5A	3.75A	6.0A	12.0A
Ripple & Noise (rms) (*6)	Range	L	< 700mV			< 800mV
		H	< 700mV			< 800mV
Ripple & Noise (p-p) (*6)			< 6.0Vp-p			< 7.0Vp-p
Settings						
Voltage (AC)	Range		0 - 310V, 155/310V Auto Range			
	Resolution		0.1V			
	Accuracy		±(0.2% of setting + 3 counts)			±(0.2% of setting + 6 counts)
Voltage (DC)	Range		0 - 420V, 210/420V Auto Range			
	Resolution		0.1V			
	Accuracy		±(0.2% of setting + 3 counts)			±(0.2% of setting + 6 counts)
Frequency	Range		DC, 5 - 1200Hz Full Range Adjust			
	Resolution		0.1Hz at 0.0 - 999.9Hz, 1Hz at 1000 - 1200Hz			
	Accuracy (*7)		±0.03% of setting (≥15Hz) ±0.3% of setting (<15Hz)			
Start Angle (Programmable Option)	Range		0-359°			
	Resolution		1°			
	Accuracy		5Hz-25Hz: ± 2° 25.1Hz-65Hz: ± 4° 65.1Hz-100Hz: ± 8° 100.1Hz-500Hz: ± 32° 500.1Hz-1000Hz: ± 60° 1000Hz-1200Hz: ± 65°			
Current Hi Limit (OC Fold=OFF) OC Fold Back (OC Fold = ON)	0 - 155V		0.05 - 5.00A	0.05 - 12.50A	0.05 - 20.00A	0.10 - 40.00A
	0 - 310V		0.05 - 2.50A	0.05 - 6.25A	0.05 - 10.00A	0.10 - 20.00A
	Resolution		0.01A			
	Accuracy		± (2.0% of setting + 4 counts)			
OC Fold Back Response Time (*8)			< 1.4S (30Hz - 1200Hz)			
Time (Programmable Option)	Range		1.0 - 999.9H 1.0 - 999.9M 1.0 - 999.9s 0.2 - 999.9ms			
	Resolution		0.1h 0.1Min 0.1s 0.1ms			
	Accuracy		± (0.1% + 0.1 Hour) ± (0.1% + 0.1 Minute) ± (0.1% + 0.1 sec) ± (0.1% + 0.1 ms)			
Time Unit			Hour, Minute, Second, ms			

Models		8505	8512	8520	8540	
Measurement						
Ramp Up (Programmable Option)	Range	0.1 - 999.9s, 0 = OFF				
	Resolution	0.1s				
	Accuracy	± (0.1% + 1 Cycle) at Output frequency ≤ 10Hz ± (0.1% + 0.1 sec) at Output frequency > 10Hz				
Frequency	Range	0.0~1200Hz				
	Resolution	0.1Hz / 1Hz				
	Accuracy	±0.1Hz @ 5 - 999.9Hz. ±1Hz @ 1000 - 1200Hz				
Voltage (AC)	Range	0 - 310V, 155/310V Auto Range				
	Resolution	0.1V				
	Accuracy	±(0.2% of reading + 3 counts) at voltage > 5V			±(0.2% of reading + 6 counts) at voltage > 5V	
Voltage (DC)	Range	0 - 420V, 210/420V Auto Range				
	Resolution	0.1V				
	Accuracy	±(0.2% of reading + 3 counts) at voltage > 5V			±(0.2% of reading + 6 counts) at voltage > 5V	
Current (AC, DC) (*9)	Range	L	0.050 - 1.200A	0.050 - 5.000A		-
		H	1.00 - 6.25A	4.00 - 15.62A	4.00 - 25.00A	0.10 - 50.00A
	Resolution	L	0.01A			-
		H	0.01A			
	Accuracy	L	± (1% of reading + 10 counts) at CF < 3			-
		H	± (0.5% of reading + 8 counts)			± (0.5% of reading + 12 counts)
Power (AC, DC) (10*)	Range	L	0.0 - 75.0W	0.0 - 300.0W		-
		H	60 - 625W	240 - 1563W	240 - 2500W	0 - 5000W
	Resolution	L	0.1W			-
		H	1W			
	Accuracy	L	± (1% of reading + 10 counts) at PF ≥ 0.35 and voltage > 5V	± (2% of reading + 15 counts) at PF ≥ 0.35 and voltage > 5V		-
		H	± (1% of reading + 5 counts) at PF ≥ 0.35 and voltage > 5V	± (1% of reading + 10 counts) at PF ≥ 0.35 and voltage > 5V	± (1% of reading + 10 counts) at PF ≥ 0.35 and voltage > 5V	± (1% of reading + 20 counts) at PF ≥ 0.35 and voltage > 5V
Power Factor	Range	0.000 - 1.000				
	Resolution	0.001				
	Accuracy	W/VA, Calculated and displayed to three significant digits				
Power Apparent (VA) (Programmable Option)	Range	L	0.0 - 75.0VA	0.0 - 300.0VA		-
		H	60 - 625VA	240 - 1563VA	240 - 2500VA	0 - 5000VA
	Resolution	L	0.1VA			
		H	1VA			
	Calculated Formula	V×A, Calculated value				

Models		8505	8512	8520	8540	
Measurement						
Peak Current Measurement (Programmable Option)	Range	0.0 - 20.0Apk	0.0 - 50.0Apk	0.0 - 80.0Apk	0.0 -160.0Apk	
	Resolution	0.1A				
	Accuracy	± (0.5% of reading +8 counts)			± (0.5% of reading +12 counts)	
Reactive Power Measurement (Programmable Option)	Range	L	0.0 - 75.0VAR	0.0 - 300.0VAR		
		H	60 - 625VAR	240 - 1563VAR	240 - 2500VAR	0 - 5000VAR
	Resolution	L	.01A			
		H	0.01A			
	Calculated Formula	$\sqrt{(VA)^2 - (W)^2}$				
Crest Factor Measurement (Programmable Option)	Range	0.00 - 10.00				
	Resolution	0.01				
	Calculated Formula	A_p / A				
Protection						
Software OCP		(102% < I _o ≤ 110%), >5 second output shut down >110% of full rated current, <1.5 second output shut down				
Output Short Shut Down Speed		<1 second				
Software OPP		≤110% of full rated current (102% < P _o ≤ 110%), > 5 second output shut down >110% of full rated current, <1.5 second output shut down				
Software OVP		Over voltage 105% of full rated voltage				
Software VSENSE OVP	H	When measurement voltage exceeds setting voltage 10V				
	L	When measurement voltage exceeds setting voltage 5V				
Software VSENSE LVP	H	When measurement voltage is lower than setting voltage 10V				
	L	When measurement voltage is lower than setting voltage 5V				
Hardware OTP		Temperature over 108°C on power component of the PFC and DDC Temperature over 100°C on heatsink of the power amplifier				
Software RCP (Reverse Current Protection)		When reverse power over 5% of full rated power				
Hardware FAN FAIL		When the cooling fan is blocked and fails				
Response Time (T _r /T _f) (* 12)		275 - 400us (Typical)				
Max DUT Input Capacitance		≤ 7.5uF				

Models	8505	8512	8520	8540
System Parameters & Features				
Calibration	1. Built-in software and external calibrated meters 2. Adjustments made through front panel			
Software Feedback Control Method (ADJ)	PID Control - Software Feedback. 12Bit A/D converter drives the amplifier.			
Meter Refresh Rate	300ms @ 5.0-39.9Hz 100ms @ 40.0-1200Hz			
Operation Key Feature	Soft key, Numeric key, Output ON/OFF/Reset key, Rotary Knob			
Hardware Interlock	Standard Hardware Interlock with direct control of amplifier output relay.			
PLC Remote	Two DB9 connectors on the rear panel for Signal Input and Output Input: Output ON, Output OFF/RESET, Interlock, File Recall M1 through M7, Trigger. *Minimum 6s pulse width for all Remote Input Keys Verify: If PLC = Verify when selecting M1-M7, the test file will load but TEST signal will be required to initiate the output. Output: Fail, Test-in-Process *Output relay contact rating is 1A/125V			
Output Type	AC, DC, AC+DC			
Voltage Sense Function (Vs)	INT / EXT (Low range: 5V / High range: 10V)			
Inrush Current	4 times current rating			
Enhanced Overload Capacity	Over current 110% can hold for 1000 ms without protection			
Interface (Programmable Option)	Standard: USB & LAN, Optional: GPIB SCPI bus commands for full instrument control. Mimic Mode option for APT 6000, 7000 & 300XAC series power sources.			
Alarm Volume Setting	Range: 0-9; 0=OFF, 1 is softest volume, 9 is loudest volume			
Graphic Display	4.3" TFT LCD (resolution: 480 x 272)			

Models		8505	8512	8520	8540
System Parameters & Features					
Models Efficiency (* 11)		≥74% (at Full load)	≥81% (at Full load)	≥84% (at Full load)	≥84% (at Full load)
Count		0 - 50000, 0 = Continuous			
Power Up		ON, OFF, LAST			
Test Results (Programmable Option)		List mode only			
Over Current Fold Back		Test results are recorded for List Mode only as long as the following conditions for test frequency and time are met: 5.0 Hz - 10.0Hz Time≥200.1msec 10.1Hz - 100.0Hz Time≥ 100.1msec 100.1Hz - 1200.0Hz Time≥ 10.1msec			
Lock		ON, OFF			
Fan Speed		Temperature-controlled fan speed			
Rack Mount Kit		Standard			
Rear Output		Terminal Block (L,N, G, Ls, Ns)			
Rear Input		AC Outlet	Terminal Block		
Memory		LIST Mode - 100 x 100 (file x sequence) MANUAL, STEP and PULSE - 100 files			
Sync Signal / Ext Trigger (Programmable Option)		ON / START / END / BOTH / OFF / EVENT, Output Signal 5V, BNC type			
Safety		CE			
Dimension by Model (mm)	W	430	430	430	430
	H	88	88	88	176
	D	500	500	500	500
Weight		15KG	15KG	15KG	28KG
Storage Environment		-40° to 75°C			
Operation Environment (* 13)		0-40°C/20-85% RH			

Models	8505	8512	8520	8540
Standard Accessories				
Interlock Disable Key (1505)			X1	
USB Cable			X1	
Shorting bar			X1	
Input/Output Terminal Protection Box			X1	
Power Cord (125Vac/10A)	X1	-	-	-
Rack Mount (2U)	X2	X2	X2	-
Rack Mount (4U)	-	-	-	X2
Handle for Rack (2U)	X2	X2	X2	-
Handle for Rack (4U)	-	-	-	X2

Why use the term “Counts”?

Associated Power Technologies publishes some specifications using COUNTS which allows us to provide a better indication of the tester’s capabilities across measurement ranges. A COUNT refers to the lowest resolution of the display for a given measurement range. For example, if the resolution for voltage is 1V then 2 counts = 2V.

Measurement Considerations

- *1) 8505, 8512, 8520VA: Input voltage is from 100V to 240V, maximum output power to resistive load, sine wave, output frequency 25Hz to 1200Hz.
- *2) At working voltage 100V / 200V.
- *3) The peak capacity of the instrument may vary from 3 to 4 times the max. rated current depending on the voltage. Please refer the following chart:

Crest Factor vs Output

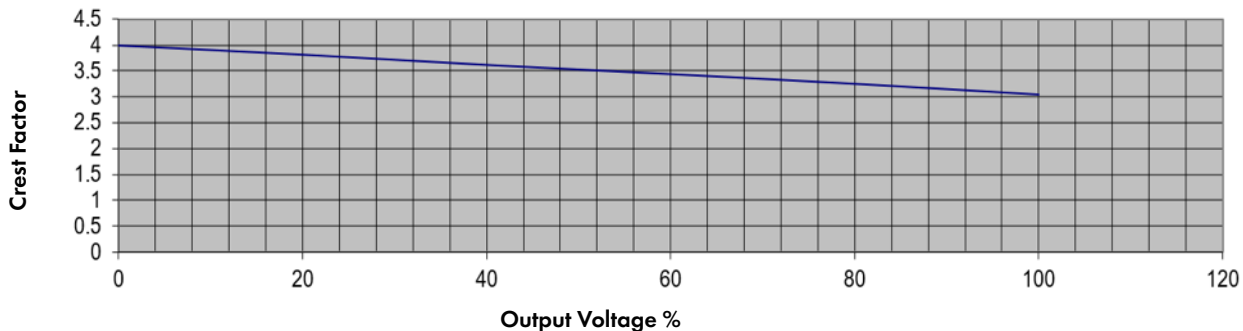

- *4 Maximum distortion is tested at 100 - 155V (155V Range) and 200 - 310V (310V Range) with maximum current to a resistive load.

*5 No load to Full load, for output frequencies of <100Hz reference the Load Regulation (Hardware) described in the table on page 8, Section 3.1.

*6 DC to 300 kHz components at voltage=0V.*7 At voltage > 10V.

*8 At output frequency 30Hz - 1200Hz. Response time < 7S at output frequency 5 - 29.9Hz. Response time < 2S at DC output. When the OC_FOLD function is enabled, the transient current and power cannot exceed 110% of the total power, otherwise the protection will be triggered.

*9 At the 10% to 100% of the maximum rated current.

*10 At the 10% to 100% of the maximum rated power. If output current exceeds the current measurement L range, power measurement accuracy follows the H range.

*11 Efficiency is tested at input voltage 220VAC with maximum power to a resistive load, output frequency 5Hz to 500Hz.

*12 At 10% to 90% of output voltage.

*13 The operating humidity is non-condensing.

3.2 Output Power, Power Factor and Output Current Considerations

The reactive output power specification of APT 8500 series, models 8505, 8512, and 8520 change depending on the power factor of the load. While the 8505, 8512 and 8520 are specified as 400VA, 800VA and 1.6kVA units respectively, they can actually output up to 25% more reactive power based on the power factor of the load, thus keeping the real power under the specified limit. The reactive power is at its peak when the power factor = 0.8. See the chart below for more information:

Models	8505	8512	8520
Output Power at pf ≤ 0.8	500VA @ 400W	1250VA @ 800W	2000VA @ 1600W
Output Power at pf > 0.8	400VA @ 400W	800VA @ 800W	1600VA @ 1600W

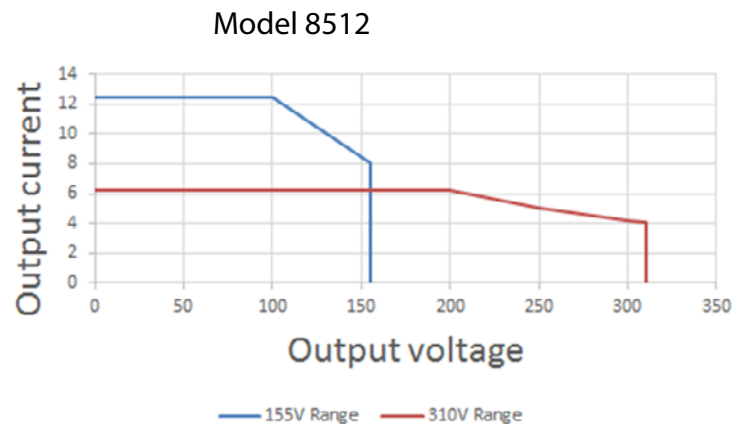
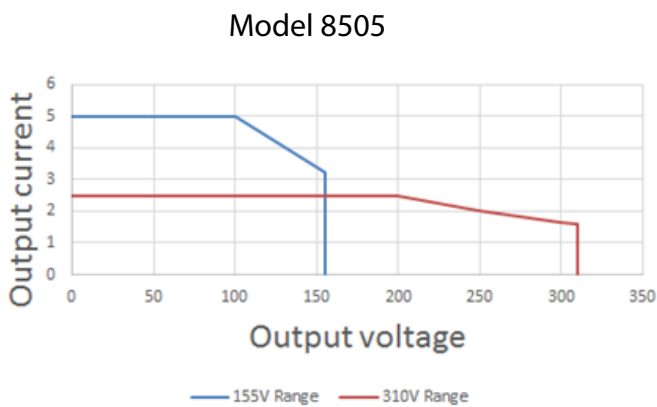

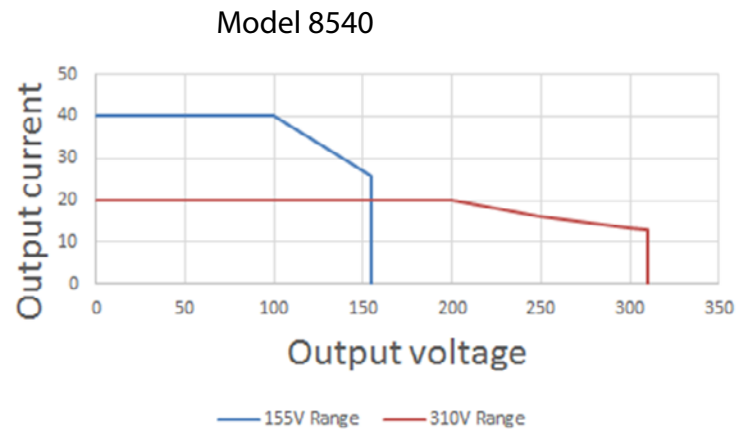
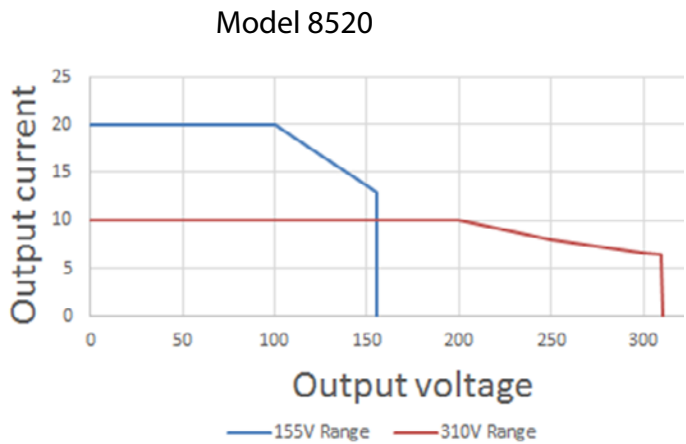

3.3 Instrument Controls

3.3.1 Front Panel Controls (All models)

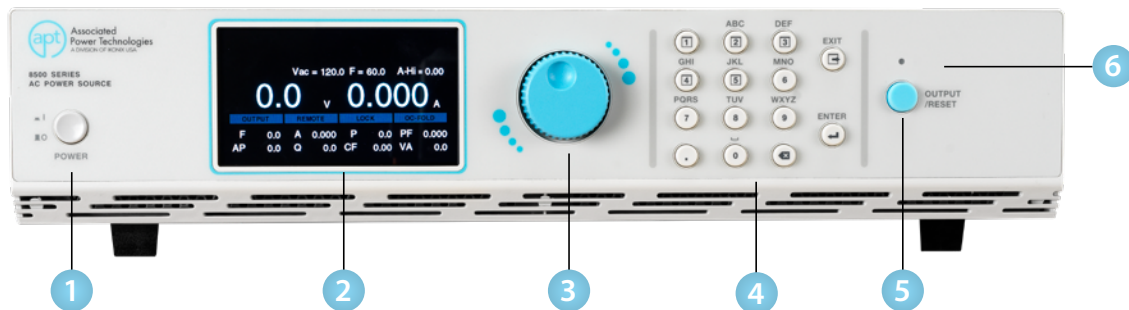

1. **Power Switch** - Power switch to power the source ON (|) and OFF (0).
2. **Graphic Display** - 480 x 272 TFT LCD.
3. **Rotary Knob** - Multifunctional rotary knob.
4. **Number Keypad** - Numeric and multifunctional keys.
5. **Output Button** - This button is used for starting and resetting a test.
6. **Output Active LED Indicator** - This LED will illuminate whenever the output of the source is active.

3.3.2 Rear Panel Controls

Model 8505

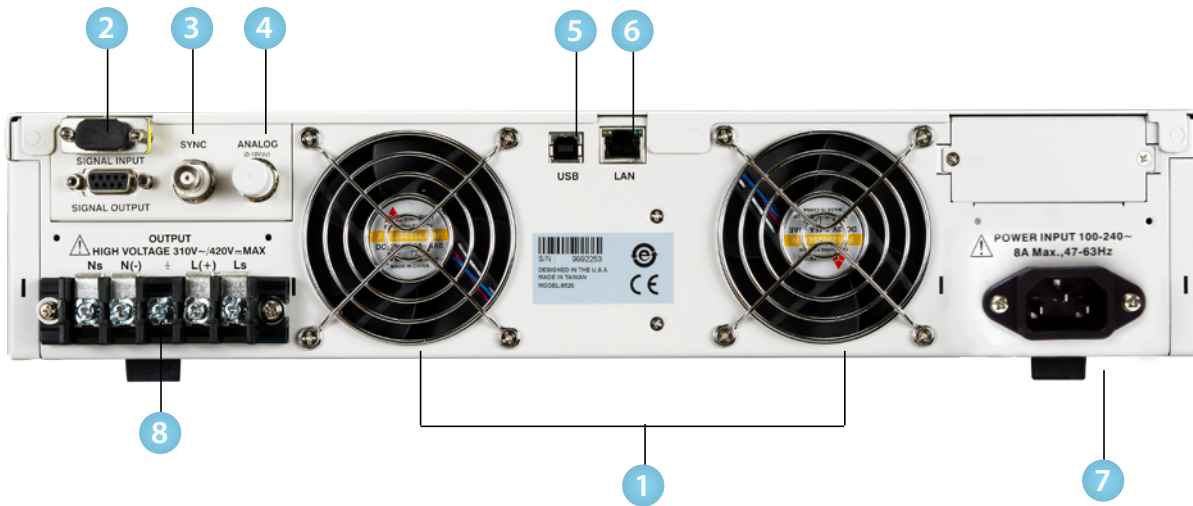

Models 8512 and 8520

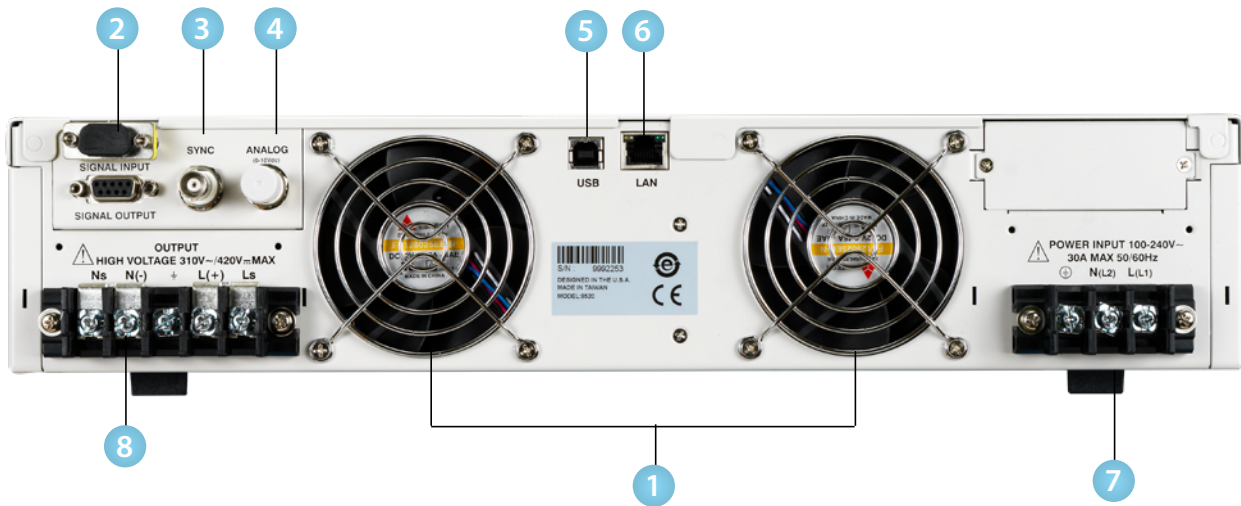

Model 8540

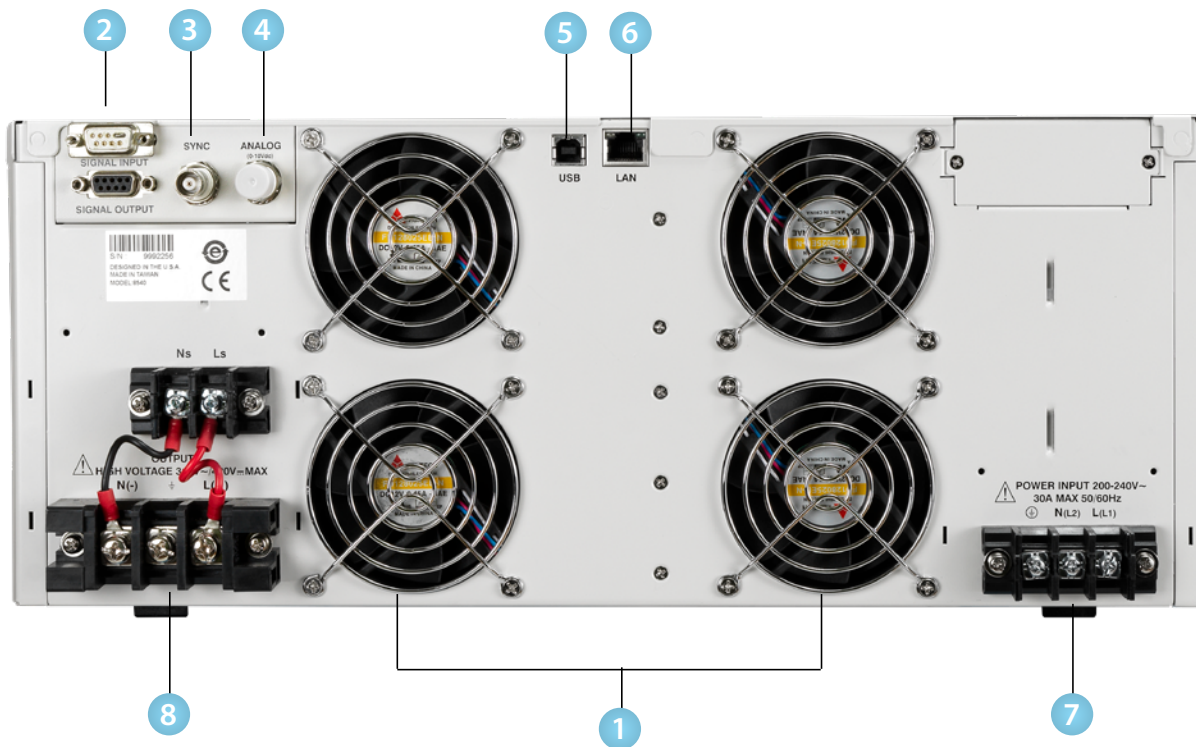

1. **Thermal Fans** - Used to cool the instrument. Automatically controlled.
2. **Signal Input/Output Connectors**
 - a. Signal Input: 9-Pin D-type subminiature male connector for remote control of OUTPUT ON, OUTPUT OFF/RESET, Output Verify, File Recall, Trigger, and REMOTE INTERLOCK DISABLE functions.
 - b. Signal Output: 9-Pin D-type subminiature female connector for monitoring FAIL and TEST-IN-PROCESS output relay signals.
3. **Sync Output Connector** - Provides the capability to monitor a 5 Vdc output signal.
4. **Analog Input Signal Connector 10V (This function is currently not available)** – The 10V analog connector allows you to remotely set the voltage applied to the device under test and measure the actual voltage and current.
5. **USB Interface Port** - Interface used to control, program, and capture data via a serial interface.
6. **Ethernet LAN Interface Port** - Interface used to control, program, and capture data via a LAN.
7. **Input Power Terminal Block/Receptacle** – Model 8505 has a standard input receptacle. Models 8512, 8520 and 8540 come with terminal block to connect input power lines to the instrument. Line, Neutral and Earth Ground screw terminals provide a secure connection. Please reference the instrument specifications and section 2.5 Power Cable for details on input wire specifications.
8. **Output Terminal Block** – Terminal block to connect output power lines for the device under test or load. Line, Neutral, Ground, Sense(L) and Sense(N) screw terminals provide a secure connection. Please reference the instrument specifications and section 2.5 Power Cable for details on output wire specifications.

3.3.3 Functional Keys

The multi-functional keys on the front panel keypad enable you to navigate through the instrument, change the meter display, name files, and change parameters. Below is a list of all multi-functional keys.

Soft Keys	Description
All keys	Press any key on the keypad (except for the OUTPUT/RESET key) to drop down the main menu.
Multi-functional keys 1-5	Allows you to change the output mode, create/edit/load test files, select System Settings, and select meter. The functions of these keys change depending on the output mode and menu you are in.
Enter	Allows you to save parameters and values.
Exit	Allows you to exit the current screen.
Output/Reset	Allows you to start output and abort/reset a test.

4. Programming Instructions

4.1 Powering on the Instrument

Turn on the Power switch located on the lower left-hand corner of the front panel. The initialization screen will appear.

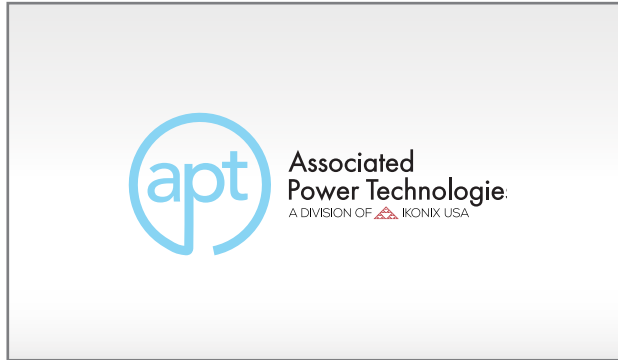

After a few seconds the initialization screen will change to the test screen. The test screen will be displayed as follows.

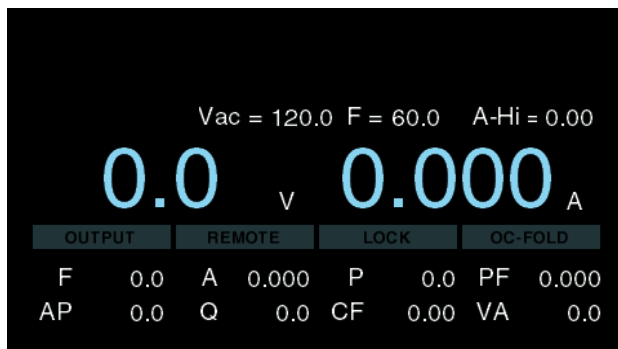

***Note – The default test screen will depend on the last test you ran and also on the System Parameter called Power Up (described in the table in Section 4.2).**

If you press any key on the keypad within the test screen a drop-down menu will appear on the top of the screen displayed as follows.

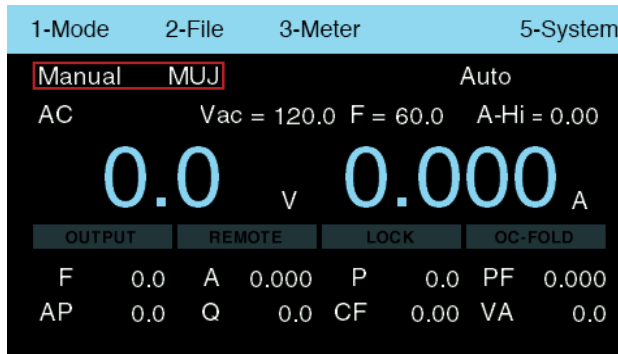

The drop-down menu will display Mode, File, Meter, and System. The output mode and test file name will also be displayed on this screen (marked in the red box) on the image above. Each selection on the menu bar is associated with a number. Use the numeric keypad and press the number for the menu that you would like to enter.

4.2 System

The system parameters change the overall operation of the AC power source. If you elect to edit the system parameters this will apply a universal change to every test file for the AC power source. You cannot independently change these settings from one test file to another. Descriptions of all System Parameters are listed in the following table:

System Parameter	Setting/Range	Description
PLC Remote	OFF ON VERIFY	<p>Allows you to initiate a test through the SIGNAL INPUT on the rear panel of the power source.</p> <p>If PLC Remote = OFF, the test must be initiated via the front panel TEST button.</p> <p>If PLC Remote = ON the front panel TEST button is disabled and a test can only be started through the rear panel SIGNAL INPUT. Upon selection of a test file the power source will start outputting.</p> <div style="display: flex; align-items: center;"> <div style="border: 2px solid orange; padding: 5px; margin-right: 10px;">WARNING</div> <p>Make sure to secure all test connections before using this function. Take all other safety precautions to avoid accidental contact with the outputs.</p> </div> <p>If PLC Remote = VERIFY, you must select a test file. The power source will only load the file, requiring you to start the test. This adds an extra step to verify that you want to start the test.</p>
V-Hi	0.0 – 310.0V	Allows you to select a maximum voltage threshold or ceiling level for the AC output voltage programmed in the test parameters.
V-Lo	0.0 – 310.0V	Allows you to select a minimum voltage threshold or floor level for the AC output voltage programmed in the test parameters.
Vdc-Hi	0.0 – 420.0V	Allows you to select a maximum voltage threshold or ceiling level for the DC output voltage programmed in the test parameters.

System Parameter	Setting/Range	Description
Vdc-Lo	0.0 – 420.0V	Allows you to select a minimum voltage threshold or floor level for the DC output voltage programmed in the test parameters.
F-Hi	5.0 – 1200Hz	Allows you to select a maximum frequency threshold or ceiling level when programming the output frequency in the parameters screen. F-Hi is only selectable when the source is configured for AC output.
F-Lo	5.0 – 1200Hz	Allows you to select a minimum frequency threshold, or floor level, when programming the output frequency in the testing parameters screen. F-Lo is only selectable when the source is configured for AC output.
Alarm	0 – 9	Controls the volume level of the audible beep, or alarm, if a failure is detected. This setting is available from a range of 0 – 9 with 9 being the loudest volume level and 0 setting the volume off.
OC - Fold	ON/OFF	Reduces the voltage, or folds the voltage back, in a linear fashion while maintaining a constant current to help run inductive loads. Response time <1400ms @ 30 - 1200Hz.
Power Up	ON OFF LAST	Controls how the output will react once the power switch is toggled on. There are three selections (OFF, ON, LAST). When the parameter is in the OFF state the operator must initialize a test by pressing the Output/Reset key on power up. If the parameter is in the ON state the output will automatically be energized when the source is powered on. If the parameter is in the LAST state the source will provide an output according to how this setting was last programmed prior to powering off the source.
Volt Sense	INT/EXT	Configures the power source for internal or external voltage sensing. If INT is selected, the instrument will measure the output voltage at the output relay. If EXT is selected, the user must connect sensing wires from the Ls and Ns terminals located on rear panel output terminal block to the DUT. Using external sense will provide a more accurate measurement when a large voltage drop occurs over the output wires.
Sync Signal	OFF ON START END BOTH EVENT	Provides an output signal that may be used to trigger an oscilloscope. The output signal is provided on the rear panel via the BNC connector labeled Sync. There are 6 Sync signal options: OFF: the Sync output is disabled, ON: the Sync Signal is active during testing, START: the Sync Signal is active only at the start of testing, END: the Sync Signal is active at the end of the test, BOTH: the Sync signal is active both at start and end of testing, EVENT: the Sync Signal is active when the output voltage changes.
Lock	ON/OFF	Allows you to lock out the buttons and rotary knob on the front panel. To exit out of the locked state press and hold the Exit key on the keypad until your hear a beep.
Mode	300XAC/6000/7000/ 8500	Allows you to set the APT 8500 Series source in compatibility mode to mimic the bus command structure of APT models 300XAC, 6000 and 7000.
LAN Config	-	Allows you to configure the settings for LAN(ENET) interface.
Baud Rate	9.6K/19.2K/38.4K /57.6K/115.2K	Allows you to specify the baud rate for Serial/USB interface.
Information	-	The Information screen displays all instrument information including: Model Number - Option, Serial Number, Company Information and Firmware Version.

Information

Model: 8512-Programmable
Serial: 9992259
Associated Power Technologies
28105 N. Keith Drive
Lake Forest, IL 60045-4546 USA
Toll Free: 1-877-322-7693
Phone: 1-847-367-4378
Fax: 1-847-367-4658
E-mail: info@aptsources.com
Web: http://www.aptsources.com/
Host: 0.00.02, DSP: 1.00.00, UI: 1.00.00

System Parameter	Setting/Range	Description
Factory Default	-	Allows you to restore default factory settings (requires a password). This function is for troubleshooting purposes. Contact us for more information. <div style="display: flex; align-items: center;"> <div style="border: 2px solid orange; padding: 5px; margin-right: 10px;">WARNING</div> <div>Performing Factory Default will delete all test files and restore all system settings.</div> </div>
Calibration	-	Allows you to select a maximum voltage threshold, or ceiling level, for the AC output voltage programmed in the test parameters.

4.3 Editing System Parameters

Some system parameters have different states that can be set and others have a range of numerical values. All the available selections and ranges are displayed at the bottom of the screen for each system parameter. For more details on each system parameter reference the table in section 4.2.

1. To edit system parameters press any key on the keypad from the test screen, a drop-down menu will appear. Press the number 5 key on the keypad to enter the System Parameter screen.



2. The System Parameter screen will open and display all the parameters available for editing. Use the rotary knob to scroll through the system parameters.



3. Some of the system parameters are listed on the next page.



4. To edit system parameters use the rotary knob to highlight the desired parameter, press the rotary knob or the ENTER key and the parameter field will turn white with a blinking cursor.



5. Rotate the knob or use the keypad to change the parameter to the desired value.

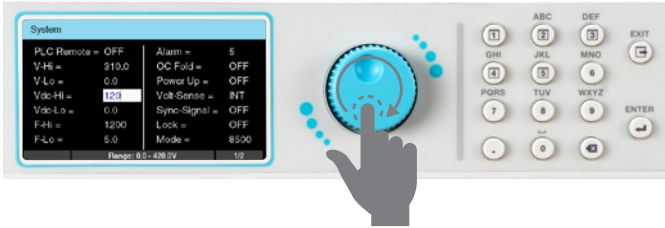

6. Press the rotary knob or the ENTER key on the keypad to save the value. The parameter will be saved and the next parameter will be highlighted.



7. Repeat this process until all system parameters have been programmed as desired. Press the EXIT key on the keypad at anytime to exit out of the System menu and back to the test screen.



4.4 Mode and File

To program a test file, you must first specify the output mode. This power source will save the test files for each output mode. Once you select the output mode, you can then start programming test files.

1. To select the output mode, press any key on the keypad from the test screen, the drop down menu bar will appear on the top of the screen.



2. Press the number 1 key on the keypad to enter the Mode menu. The four selections for Mode will be displayed on the menu bar, all associated with a number.



4.4.1 Create Test File – Manual Mode

1. From the Mode menu press the number 1 key on the keypad to change the Mode to Manual. The next screen displayed will reflect the Mode as Manual, along with a test file name or a “No File Loaded” message if no test file has been loaded in Manual Mode.



2. Once the Mode has been set to Manual press any key to drop down the menu bar then press the number 2 key on the keypad to enter the File menu.



3. The File screen will be displayed and the selections on the menu bar will change. If there are no previously saved test files for Manual Mode the screen of the File menu will display the selections to Add, Edit or Load a test file on the menu bar. The Next selection on the menu bar will not do anything.



4. If there are any test files previously saved for Manual Mode they will be listed on this screen.



5. Press the number 4 key on the keypad to view the next page of the File menu. The next page will display the selections to Copy or Delete an existing test file. Selecting Next (by pressing the number 3 key on the keypad) will display the previous page of the File menu.



6. To start adding a test file press the number 1 key on the keypad to select Add.



7. The next screen will display a field with a blinking cursor to enter a name for the file.



8. Use the keypad to enter a name for the test file (23 character limit).



9. After entering the file name press the ENTER key on the keypad to save the file name and display the test parameters for editing.



10. The test parameters can be edited in the exact same manner as the system parameters, using a combination of the rotary knob and keypad. To edit a test parameter use the rotary knob to highlight the parameter and press the rotary knob to edit the parameter.



11. Use the rotary knob or keypad to edit the test parameter value. The available range or settings for the test parameter being edited will be displayed at the bottom of the screen. Once the desired value of the test parameter is entered press the rotary knob or the ENTER key on the keypad to save the value and move to the next test parameter.



12. Once all test parameters have been programmed press the EXIT key on the keypad and the screen will display your newly created test file (along with other test files that may have already been saved).



4.4.2 Manual Mode - Test Parameters

The Manual Mode allows you to program an AC, DC or AC+DC (coupled) output. Along with the standard Sine wave, you can also choose from Triangle, Square and Clipped output waveform. Detailed descriptions of all the available test parameters in Manual Mode are listed in the following table.

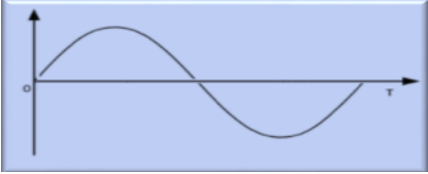
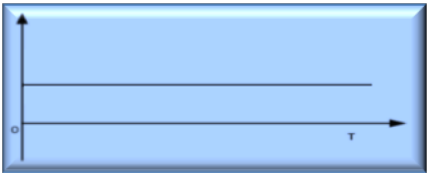
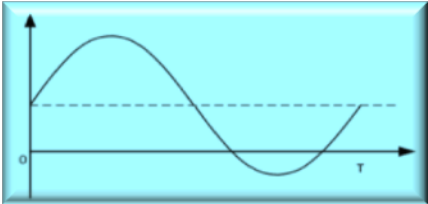
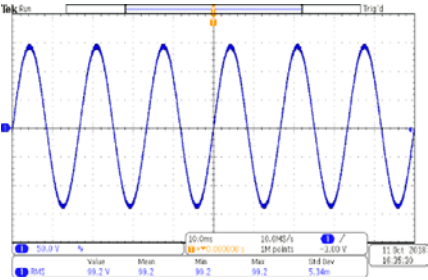
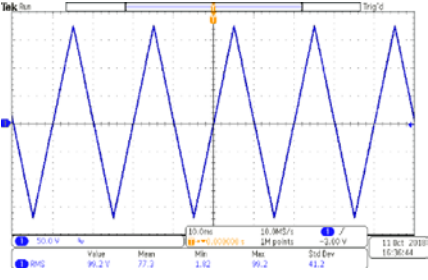
Manual Mode - Test Parameters		
Parameter	Setting/Range	Description
Couple	AC	Sets the power source to output a simple Sine wave output. 
	DC	Sets the power source for a DC output. 
	AC+DC	Sets the power source for a coupled AC+DC output. 
Wave	SINE (0 - 155V, 0 - 310V)	Sets the powers source for a sine output waveform. 
	TRIANGLE (0 - 126V, 0 - 253V)	Sets the power source for a triangle output waveform. 

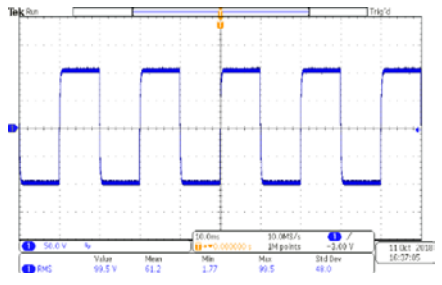
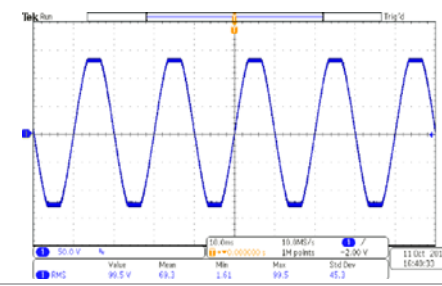
Manual Mode - Test Parameters		
Parameter	Setting/Range	Description
WAVE	SQUARE (0 - 219V, 0 - 310 V)	<p>Sets the power source for a square output waveform.</p> 
	CSIN (0 - 155V, 0 - 310V)	<p>Sets the power source for a clipped-sine waveform.</p> 
Range	Auto	Sets the power source in an Auto Range mode. The power source will automatically interpret the voltage range and switch to high or low voltage output range.
	High	Sets the power source in the High Range mode for voltage output. The current will be limited to half of its full range. See section 3.1 Specifications.
	Low	Sets the power source in the Low Range mode for voltage output. Full current will be available in this mode. See section 3.1 Specifications.
Vac	0 - 310V	AC voltage output
Vdc	0 – 420V	DC voltage output (only available in DC or AC+DC couple modes).
F	5 – 1200Hz	Output frequency for AC or AC+DC couple modes.
Ramp up	0.1 - 999.9s	Provides flexibility to increase the voltage output over a duration of time prior to achieving the programmed output voltage.
Start Angle	0 - 359°	Provides flexibility to select the starting angle of the sine wave when the output voltage is generated.
A-Hi	Depends on the model. See section 3.1 Specifications	Provides flexibility to program a maximum current threshold or ceiling level. When this level is reached a failure will occur.
P-Hi	Depends on the model. See section 3.1 Specifications	Provides flexibility to program a maximum wattage threshold or ceiling level. When this level is reached a failure will occur.
A-Hi Delay	0.0 – 999.9s	Provides flexibility to program a time delay to allow the A-Hi limit to be exceeded (for an amount of time) without resulting in the test to fail.

4.4.3 Create Test File – List Mode

1. From the Mode menu press the number 2 key on the keypad to change the mode to List. The next screen displayed will reflect the mode as List, along with a test file name or a “No File Loaded” message if no test file has been loaded in the List Mode.



2. Once the mode has been set to List press any key to drop down the menu bar and press the number 2 key on the keypad to enter the File menu.



3. The File screen will be displayed and the selections on the menu bar will change. If there are no previously saved test files for List Mode the screen of the File menu will display the selections to Add, Edit or Load a test file on the menu bar. The Next selection on the menu bar will not do anything.



4. To start adding a test file press the number 1 key on the keypad to select Add.



5. The next screen will display a field with a blinking cursor to enter a name for the file.



6. Use the keypad to enter a name for the test file (23 character limit).



7. After entering the file name press the ENTER key on the keypad to save the file name and display the Program Setup along with the first sequence. The next screen will also display the Add and Edit option on the menu bar.



8. Use the rotary knob to highlight Program Setup or the first sequence parameters. To edit the parameters you can do one of the following: press the rotary knob, press the ENTER key or the number 2 key on the keypad. The Program Setup screen displays the following parameters.



9. The sequence setup has two screens, one for test parameters and another that allows you to program additional metering. To view the sequence test parameters highlight the first sequence and press the rotary knob or the ENTER key.



10. The next screen will display the first page of the sequence setup. Use the rotary knob to view both screens of the sequence setup.



The Program Setup and sequence parameters can be edited in the exact same manner as described in the previous sections, using a combination of rotary knob and keypad.

1. To Add a new sequence press the number 1 key on the keypad, to Edit press the number 2 key, and to Copy a sequence press the number 3 key as displayed on the menu bar.



2. When choosing to copy a sequence the message on the screen below will be displayed. Select 1 for Yes or 2 for No.



3. When copying a sequence, if Yes is selected the next screen will display the second sequence along with options on the menu bar to Add, Edit, copy or Delete a sequence.



4. Once all the Program Setup parameters have been programmed and all the sequences have been created press the EXIT key on the keypad and the screen will display your newly created test file (along with other test files that may have already been saved).



4.4.4 List Mode – Test Parameters

The List Mode allows you to create and generate complex output sequences with varying time, amplitude, frequency, and voltage. The List Mode can be used to create a wide range of waveforms to simulate power grid faults and disturbances. A typical waveform for List Mode with three sequences will perform as follows.

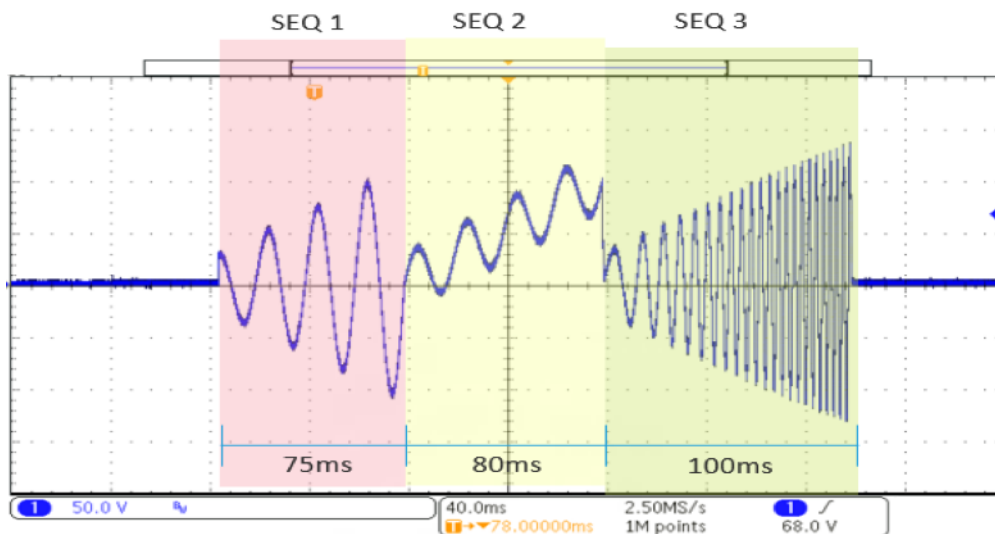

The previous waveform was generated using the following parameters of the List Mode sequences:

SEQ 1		SEQ 2		SEQ 3	
Wave	Sine	Wave	Sine	Wave	Sine
Start Angle	90	Start Angle	0	Start Angle	0
Vs	20	Vs	20	Vs	20
Fs	50	Fs	50	Fs	50
DCs	0	DCs	0	DCs	0
Ve	80	Ve	20	Ve	100
Fe	50	Fe	50	Fe	400
DCe	0	DCe	100	DCe	0
Time unit	ms	Time unit	ms	Time unit	ms
Time	75	Time	80	Time	100

Detailed descriptions of all the available test parameters in the List Mode are listed in the following table:

List Mode - Sequence Parameters		
Parameter	Setting/Range	Description
Wave	SINE, TRIANGLE, SQUARE, CSIN	Sets the output waveform to the desired type.
Start Angle	0 - 359°	Provides flexibility to select the starting angle of the sine wave when the output voltage is generated.
Vs	0.0 – 310.0V	Start AC voltage for the sequence.
Fs	5 – 1200Hz	Start frequency for the sequence.
DCs	0.0 – 420.0V	Start DC voltage for the sequence.
Ve	0.0 – 310.0V	End AC voltage for the sequence.
Fe	5 – 1200Hz	End frequency for the sequence.
DCe	0.0 – 420.0V	End DC voltage for the sequence.
Time Unit	ms, s, m, h	Sets the units of time for a sequence.
Time	1.0 – 999.9s	Sets time for the sequence.
A-Hi Delay	0.0 – 999.9s	Provides flexibility to program a time delay to allow the A-Hi limit to be exceeded (for an amount of time) without resulting in the test to fail.

List Mode - Additional Metering

Parameter	Setting/Range	Description
A-Hi	See Specifications in section 3.1	Provides the flexibility to program a maximum current threshold or ceiling level. When this level is reached a failure will occur.
A-Lo	See Specifications in section 3.1	Provides the flexibility to program a minimum current threshold or floor level. If a minimum current level is not reached a failure will occur. This ensures a load is attached to the power source and there is a minimum current present.
P-Hi	See Specifications in section 3.1	Provides flexibility to program a maximum wattage threshold or ceiling level. When this level is reached a failure will occur.
P-Lo	See Specifications in section 3.1	Provides flexibility to program a minimum wattage threshold or floor level. If a minimum wattage level is not reached a failure will occur. This ensures a load is attached to the power source and there is a minimum wattage present.
PF-Hi	0.000-1.000	Provides flexibility to program a maximum power factor threshold or ceiling level. When this level is reached a failure will occur.
PF-Lo	0.000-1.000	Provides flexibility to program a minimum power factor threshold or floor level. If a minimum power factor level is not reached a failure will occur. This ensures a load is attached to the power source and there is a minimum power factor present.
AP-Hi	See Specifications in section 3.1	Provides flexibility to program a maximum peak current threshold or ceiling level. When this level is reached a failure will occur.
AP-Lo	See Specifications in section 3.1	Provides flexibility to program a minimum peak current threshold or floor level. If a minimum peak current level is not reached a failure will occur. This ensures a load is attached to the power source and there is a minimum peak current present.
Q-Hi	See Specifications in section 3.1	Provides flexibility to program a maximum reactive power (VAR) threshold or ceiling level. When this level is reached a failure will occur.
Q-Lo	See Specifications in section 3.1	Provides flexibility to program a minimum reactive power (VAR) threshold or floor level. If a minimum VAR level is not reached a failure will occur. This ensures a load is attached to the power source and there is a minimum VAR present.
CF-Hi	0.00 – 10.00	Provides flexibility to program a maximum crest factor threshold or ceiling level. When this level is reached a failure will occur.
CF-Lo	0.00 – 10.00	Provides flexibility to program a minimum crest factor threshold or floor level. If a minimum crest factor level is not reached a failure will occur. This ensures a load is attached to the power source and there is a minimum crest factor present.
VA-Hi	See Specifications in section 3.1	Provides flexibility to program a maximum apparent power (VA) threshold or ceiling level. When this level is reached a failure will occur.
VA-Lo	See Specifications in section 3.1	Provides flexibility to program a minimum apparent power (VA) threshold or floor level. If a minimum VA level is not reached a failure will occur. This ensures a load is attached to the power source and there is a minimum VA present.

List Mode - Program Setup

List Mode Program Setup parameters only apply when Trigger is set to Manual. These parameters determine what happens before you trigger the first sequence of the List Mode output. If the Trigger is set to Auto and you start the test these parameters will not matter since the first sequence starts right away.

Parameter	Setting/Range	Description
Count	0 – 50000, 0=Off	Sets the number of counts.
Trigger	Auto/Manual	Sets the trigger to auto or manual for triggering the counts.
Base	Time/Cycle	Sets the base to time or cycle.
	Auto	Sets the power source in an Auto Range mode. The power source will automatically interpret the voltage range and switch to high or low voltage output range.
	High	Sets the power source in the High Range mode for voltage output. The current will be limited to half of its full range. See section 3.1 Specifications.
	Low	Sets the power source in the Low Range mode for voltage output. Full current will be available in this mode. See section 3.1 Specifications.
Vac	0.0 – 310.0V	Starting AC voltage for the test when Trigger is set to Manual. This will be the AC voltage output until you trigger the sequence manually.
F	5.0 – 1200Hz	Starting frequency for the test when Trigger is set to Manual. This will be the frequency of the output until the you trigger the sequence manually.
Vdc	0.0 – 420.0V	Starting DC voltage for the test when Trigger is set to Manual. This will be the DC voltage output until you trigger the sequence manually.
Angle CONT	OFF/ON	Phase angle of the AC output. If set to OFF, each SEQ with an AC wave simply starts its phase at whatever its Start Angle is set to. If Angle CONT is set to ON, the SEQ Start Angles are ignored, the phase attempts to be "continuous", and the next SEQ phase angle is set to whatever the last SEQ ended at.

4.4.5 Create Test File – Step Mode

1. From the Mode menu press the number 3 key on the keypad to change the Mode to Step. The next screen displayed will reflect the Mode as Step, along with a test file name or a “No File Loaded” message if no test file has been loaded in the List Mode.



2. Once the Mode has been set to Step press any key to drop down the menu bar and press the number 2 key on the keypad to enter the File menu.



3. The File screen will be displayed and the selections on the menu bar will change. If there are no previously saved test files for Step Mode the screen of the File menu will display the selections to Add, Edit or Load a test file on the menu bar. The Next selection on the menu bar will not do anything.



4. To start adding a test file press the number 1 key on the keypad to select Add.



5. The next screen will display a field with a blinking cursor to enter a name for the file.



6. Use the keypad to enter a name for the test file (23 character limit).



7. After entering the file name press the ENTER key on the keypad to save the file name and display the test parameters for editing.



8. The test parameters can be edited in the exact same manner as the system parameters, using a combination of the rotary knob and keypad.

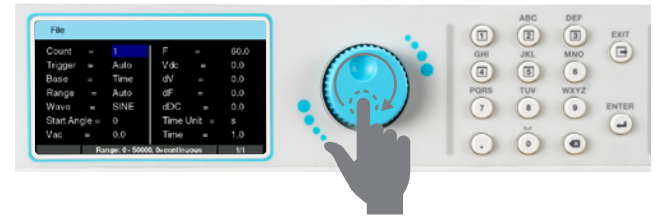

4.4.6 Step Mode – Test Parameters

The Step Mode allows you to create and generate step-up outputs based on your defined voltage, frequency, and interval settings. A typical waveform for Step Mode will look like the following.

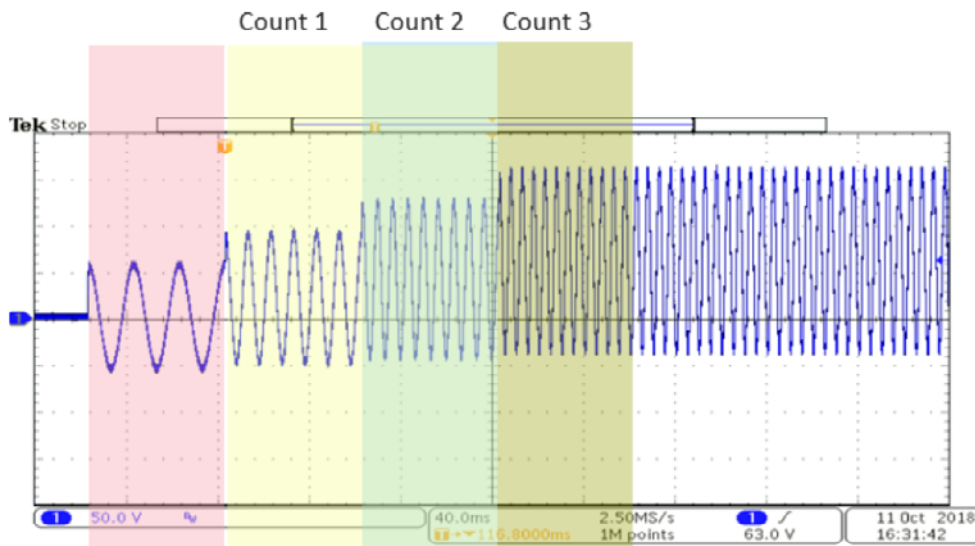

The above waveform was generated using the following parameters of the Step Mode.

File					
Count	=	3	F	=	50.0
Trigger	=	Auto	Vdc	=	0.0
Base	=	Time	dV	=	10.0
Range	=	High	dF	=	50.0
Wave	=	SINE	dDC	=	20.0
Start Angle	=	90	Time Unit	=	ms
Vac	=	40.0	Time	=	60.0

Detailed descriptions of all the available test parameters in Step Mode are indexed in the following table:

Step Mode - Test Parameters		
Parameter	Setting/Range	Description
Count	0 – 50000 0=Off	Sets the number of counts.
Trigger	Auto/Manual	Sets the trigger to auto or manual for triggering the counts.
Base	Time/Cycle	Sets the base to time or cycle.
Range	Auto	Sets the power source in an Auto Range mode. The power source will automatically interpret the voltage range and switch to high or low voltage output range.
	High	Sets the power source in the High Range mode for voltage output. The current will be limited to half of its full range. See section 3.1 Specifications.
	Low	Sets the power source in the Low Range mode for voltage output. Full current will be available in this mode. See section 3.1 Specifications.
Wave	SINE, TRIANGLE, SQUARE, CSIN	Sets the output waveform to the desired type. See section 4.4.2 for a graphical representation of each wave type.
Start Angle	0 - 359°	Provides flexibility to select the starting angle of the sine wave when the output voltage is generated.
Vac	0.0 – 310.0V	Starting AC voltage for the sequence.
F	5 – 1200Hz	Starting frequency for the sequence.
Vdc	0.0 – 420.0V	Starting DC voltage for the sequence.
dV	0.0 – 310.0V	Sets the step-up or step-down AC voltage.
dF	5 – 1200Hz	Sets the step-up or step-down frequency.
dDC	0.0 – 420.0V	Sets the step-up or step-down DC voltage.
Time Unit	ms, s, m, h	Sets the unit of time for the counts.
Time	1.0 – 999.9s	Sets time for the counts.

4.4.7 Create Test File – Pulse Mode

1. From the Mode menu press the number 4 key on the keypad to change the Mode to Pulse. The next screen displayed will reflect the Mode as Pulse, along with a test file name, or a “No File Loaded” message if no test file has been loaded in the List Mode.



2. Once the Mode has been set to Pulse, press any key to drop down the menu bar and press the number 2 key on the keypad to enter the File menu.



3. The File screen will be displayed and the selections on the menu bar will change. If there are no previously saved test files for Step Mode the screen of the File menu will display the selections to Add, Edit or Load a test file on the menu bar. The Next selection on the menu bar will not do anything.



5. The next screen will display a field with a blinking cursor to enter a name for the file.



6. Use the keypad to enter a name for the test file (23 character limit).



7. After entering the file name, press the ENTER key on the keypad to save the file name and display the test parameters for editing.



8. The test parameters can be edited in the exact same manner as the system parameters using a combination of the rotary knob and keypad.



4.4.8 Pulse Mode – Test Parameters

The Pulse Mode allows the user to create and generate single or multiple pulses with your defined voltage. The Pulse mode can be used to create a wide range of waveforms to simulate power grid faults and disturbances. A typical waveform for Pulse Mode with three sequences will look as follows.

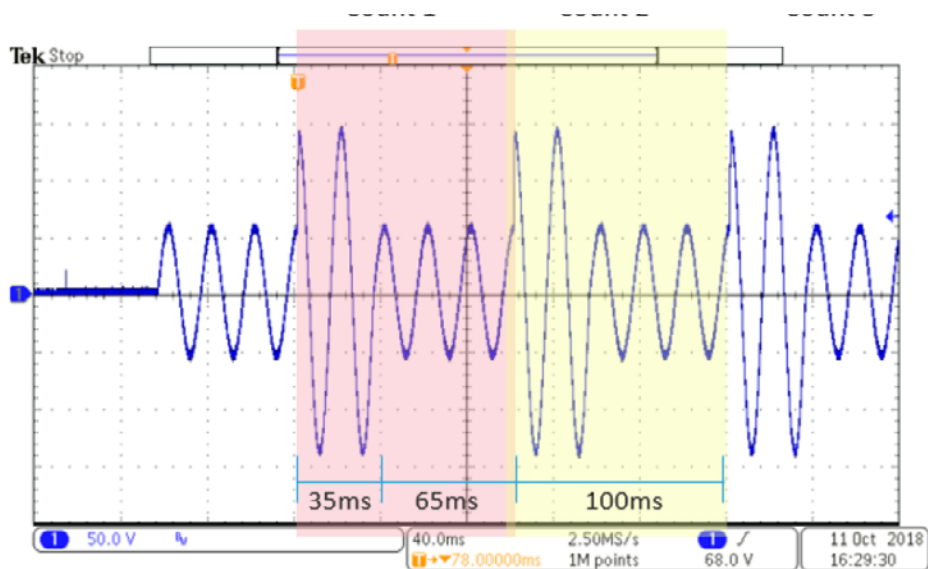

The above waveform was generated using the following parameters of the Step Mode.

File	
Count	= 3
Trigger	= Auto
Range	= Auto
Vac	= 50.0
F	= 50.0
Vdc	= 0.0
Start Angle	= 90
Trans-Vac	= 100.0
Trans-Vdc	= 0.0
Duty	= 35
Period	= 100.0

Detailed descriptions of all the available test parameters in the Pulse Mode are listed in the following table:

Step Mode - Test Parameters		
Parameter	Setting/Range	Description
Count	0 – 50000 0=Off	Sets the number of counts.
Trigger	Auto/Manual	Sets the trigger to auto or manual for triggering the counts.
Range	Auto	Sets the power source in an Auto Range mode. The power source will automatically interpret the voltage range and switch to high or low voltage output range.
	High	Sets the power source in the High Range mode for voltage output. The current will be limited to half of its full range. See section 3.1 Specifications.
	Low	Sets the power source in the Low Range mode for voltage output. Full current will be available in the mode. See section 3.1 Specifications.
Wave	SINE, TRIANGLE, SQUARE, CSIN	Sets the output waveform to the desired type.
Vac	0.0 – 310.0V	Starting AC voltage for the sequence.
F	5 – 1200Hz	Starting frequency for the sequence.
Vdc	0.0 – 420.0V	Starting DC voltage for the sequence.
Start Angle	0 - 359°	Provides flexibility to select the starting angle of the sine wave when the output voltage is generated.
Trans Vac	0.0 – 310.0V	Sets the transient AC voltage.
Trans Vdc	0.0 – 420.0V	Sets the transient DC voltage.
Duty	0 -100%	Sets the duty cycle of the transient voltage for the period.
Period	0 – 999.9ms	Sets the total time period for each count.

4.5 Edit, Copy, Delete, and Load Test File

After creating test files the user has the option to edit, delete, copy, or load the test file to start testing.

4.5.1 Edit

1. To edit an existing test file the user must first select the Mode in which the test file was created. From the test screen press any key to drop down the menu bar and press the number 1 key on the keypad.



2. The Mode options will appear on the drop down menu bar.



3. Using the keypad, select the desired Mode. For example, if the number 1 key is pressed the Manual Mode will be selected and the screen will display the mode and the file name that was last used in this mode.



4. The menu bar will display the selection for File Press the number 2 key on the keypad to enter the File menu and all the previously created test files will be listed.



5. Use the rotary knob to highlight the file you wish to edit. Press the rotary knob to view the test parameters. Once the file name is highlighted, the user can also press the number 2 key, or the ENTER key, on the keypad to view the test parameters.



6. To edit the test parameters use a combination of the rotary knob and keypad, as explained in the previous sections. Once all the test parameters have been edited, press the EXIT key on the keypad to view the list of test files and press the EXIT key again to go back to the test menu.



4.5.2 Copy

1. When the File menu appears press the number 4 key on the keypad to view the Next page.



2. The selections in the menu bar will change and the option to select Copy, Delete, or Next will appear.



3. To copy a file, use the rotary knob to highlight the file to be copied and press the number 1 key on the keypad.



4. The following message will appear on the screen to confirm if you would like to proceed with copying the selected file. Press the number 1 key on the keypad to select Yes, or press the number 2 key on the keypad to select No.



5. If Yes is selected the screen will display a field for entering a file name for the copied file.



6. Use the keypad to type the file name and press the ENTER key to save the newly copied file.



7. The next screen will display all the test parameters for the copied file. Use a combination of rotary knob and keypad if you wish to edit the test parameters. Press the EXIT key and the screen will display the newly copied test file along with other files.

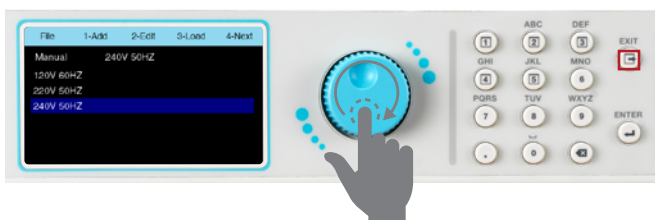

4.5.3 Delete

1. To Delete a test file select the Mode and go to the File menu to view the list of test files. Press the number 4 key on the keypad to view the next page.



2. Use the rotary knob to select the file to be deleted. The Delete selection will appear on the menu bar, press the number 2 key on the keypad to delete the highlighted file.



3. The following message will appear on the screen to confirm that you would like to proceed with deleting the selected file. Press the number 1 key on the keypad to select Yes, or press the number 2 key on the keypad to select No. If Yes is selected the file will be permanently deleted and the screen will display any remaining test files.

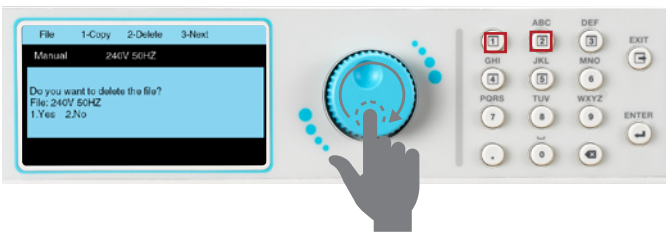

4.5.4 Load

1. To load a file select the Mode in which the file was created and access the File menu. The selection to Load will appear on the menu bar.



2. Press the number 3 key on the keypad to select Load and the screen will change to the test screen. The test file name that was loaded will appear on the screen.



4. The power source will start outputting if you press the OUTPUT/RESET key on the front panel. Make sure all of the output connections are secure and all other safety precautions are taken.

5. Perform Test

Once a test file is loaded, the power source is ready to start outputting. Make all of the necessary test connections to the DUT (Device Under Test) and perform all safety measures before performing the test. Pressing the OUTPUT/RESET key will start a test.

5.1 Meter

1. The Meter setting of the power source provides flexibility to choose any of the available meters to appear along side the default Voltage meter. The two main default meters of the test screen are Voltage (V) and Current (A). After loading the test file press any key on the keypad to drop down the menu bar and press the number 3 key on the keypad to select your meter of choice to be displayed along with the Voltage meter.



2. The menu bar will display the selections for different meters along with a selection to view the next page.



3. Use the keypad to select the desired meter to be displayed as the main meter along with voltage.



5.2 Manual Mode

1. The Manual Mode test screen will appear similar to the following.



2. The user can press the OUTPUT/RESET key at any time during the test to end/abort the test.



5.3 List Mode

1. The List Mode test screen will appear similar to the following.



2. The user can press the OUTPUT/RESET key at any time during the test to end/abort the test.



5.4 Step Mode

1. The Step Mode test screen will appear similar to the following.



2. The user can press the OUTPUT/RESET key at any time during the test to end/abort the test.



5.5 Pulse Mode

1. The Pulse Mode test screen will appear similar to the following.



2. The user can press the OUTPUT/RESET key at any time during the test to end/abort the test.



5.6 Results

1. The test results are available for viewing in List Mode only. Users can view the test results once the test has ended by pressing any key on the keypad to drop down the menu bar and pressing the number 4 key on the keypad.



2. The Results screen will appear and the rotary knob can be used to view the results.

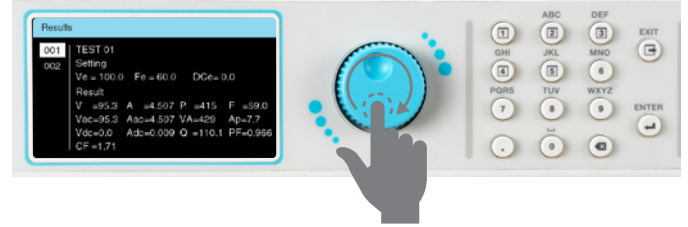

*Note – If the test times are less than what is described in the table of conditions below, the instrument will not save the test results due to very short time duration available for storing the results:

Test Frequency	Test Time
5 – 10Hz	200ms
10 – 100Hz	100ms
100 – 1200Hz	10ms

3. The test results will be cleared upon powering OFF the power source. The Results screen will appear as follows if there are no results available to be displayed.



5.7 Perform Test Screen Considerations

The Perform Test screen displays a few select System Parameters if they were enabled by the user prior to performing a test. If the power source is controlled using a PC an icon appears on the screen to indicate PC control. For details on System Parameters refer to section 4.2 System Parameters.

LOCK – If the Lock parameter is enabled and a test is performed LOCK will be highlighted on the screen.

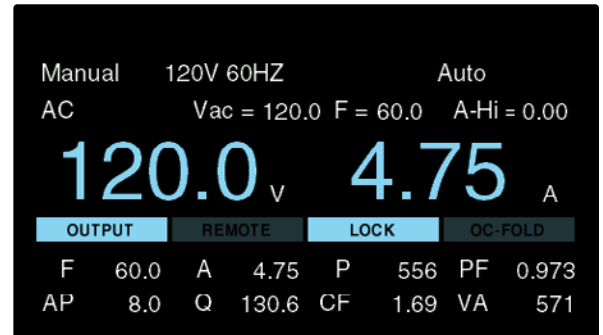

OC – FOLD – If the OC-FOLD parameter is enabled and test is performed OC-FOLD will be highlighted on the screen.

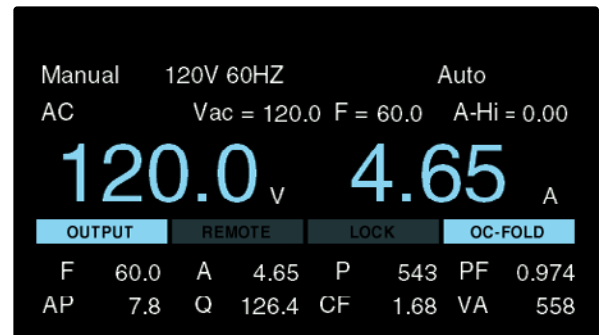

PLC Remote – If the PLC Remote parameter is enabled and a test is performed via a PLC remote control REMOTE will be highlighted on the screen.

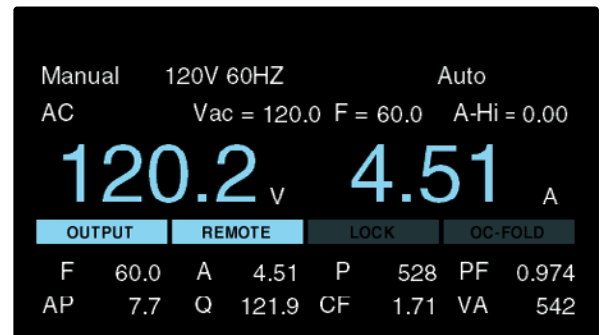

USB, LAN or GPIB – If the test is initiated using the USB, LAN or optional GPIB interface an icon will appear on the top right section of the screen to indicate PC control.

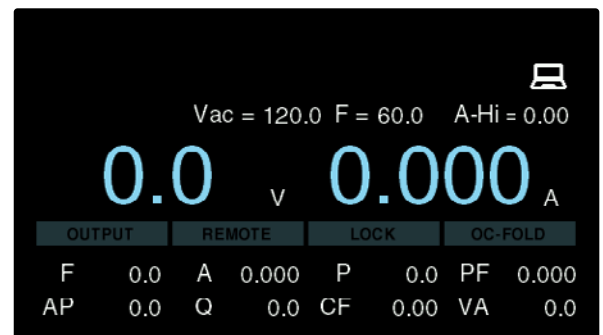

5.8 Error and Failure Messages

The APT 8500 Series power sources can display several error or failure messages during an abnormal condition. When an abnormal condition occurs, the output will disable and the alarm will sound. The OUTPUT/RESET LED indicator will also begin flashing. See sections 3.1 Specifications and 4.2 System for details on the available ranges for all test and system parameters.

WARNING

All error messages occur in abnormal conditions and therefore must be recorded. Check the cause of the error to ensure the problem is eliminated before restarting the operation, or contact Associated Power Technologies, or our official distributors for further assistance.

The following table describes all types of error and failure messages that can be displayed on the screen during an abnormal condition while the power source is operating.

Code	Description	Process to Clear			
		Press EXIT key	Wait 5sec, Press EXIT key	Reboot. If error message repeats contact manufacturer	Contact Manufacturer
OVP_PEAK	Displayed if the output voltage exceeds the peak output voltage range: Hi - 482.2V, Lo - 241.1V		•		
OVP	Displayed if the output voltage exceeds the output voltage range: Hi - 460.26V, Lo - 230.13V	•			
OCP_PEAK	Displayed if the output current exceeds the peak (Inrush) output current by 10% in the Lo range (0-155V) and by 20% in the Hi range (0-310V).		•		
OCP	Displayed when the output current exceeds 10% of the maximum output current range.	•			
OPP_PEAK	Displayed if the power output exceeds the peak power output range: Model 8505: 3111 W Model 8512: 7778W Model 8520: 12445W Model 8540: 24890W		•		
OPP	Displayed if the power output exceeds the maximum power output by 10%.	•			

Code	Description	Process to Clear			
		Press EXIT key	Wait 5sec, Press EXIT key	Reboot. If error message repeats contact manufacturer	Contact Manufacturer
VSENSE_INT_OVP	Displayed when the output voltage measurement is greater than the output voltage setting by 5V in the Lo range and 10V in the Hi range. Displayed when the System Parameter Volt Sense=INT	●			
VSENSE_INT_LVP	Displayed when the output voltage measurement is greater than the output voltage setting by 5V in the Lo range and by 10V in the Hi range. Displayed when the System Parameter Volt Sense=EXT	●			
VSENSE_EXT_OVP	Displayed if the output current exceeds the peak (Inrush) output current by 10% in the Lo range (0-155V) and by 20% in the Hi range (0-310V).	●			
VSENSE_EXT_LVP	Displayed when the output voltage measurement is less than the output voltage setting by 5V in the Lo range and by 10V in the Hi range. Displayed when the System Parameter Volt Sense=EXT	●			
FAN_FAIL	Displayed when the cooling fan(s) fail.			●	●
DA_OTP	Displayed when the temperature of the AMP board reaches 100°C.			●	●
DD_FAIL	Displayed when the DD board internal check fails.			●	●
INT_TEST_FAIL	Displayed when the voltage measurement is different from the setting by $\pm 20V$ during internal verification.	●			
A-Hi	Displayed when the output current exceeds the A-Hi test parameter setting.	●			
A-Lo	Displayed when the output current stays below the A-Lo test parameter setting. (List Mode only)	●			
OUTPUT_SHORT	Displayed when a short is detected on the outputs.			●	

Code	Description	Process to Clear			
		Press EXIT key	Wait 5sec, Press EXIT key	Reboot. If error message repeats contact manufacturer	Contact Manufacturer
SET_FAIL	Displayed when the voltage value for AC+DC coupling is greater than the voltage range: Hi – 438V, Lo – 219V	•			
RCP-PEAK	Displayed when the power source detects negative current feeding back into the source. RCP_PEAK will display when the negative peak power exceeds the following values: Model 8505 – 100W Model 8512 – 250W Model 8520 – 400W Model 8540 – 800W		•		
RCP	Displayed when the power source detects negative current feeding back into the source. RCP will display when the negative power exceeds the following values: Model 8505 – 25W Model 8512 – 62.5WW Model 8520 – 100W Model 8540 – 200W	•			
AC-OVP	Displayed when the input voltage to the power source is detected to be greater than 272V.			•	•
AC-LVP	Displayed when the input voltage to the power source is detected to be less than 81V for models 8505, 8512 & 8520, and less than 171V for model 8540.			•	•
PFC_OVP	Displayed when the voltage is greater than 425V for power factor correction.			•	•
PFC_LVP	Displayed when the voltage is less than 310V for power factor correction.			•	•
IPFC_OCP_Peak	Displayed when the peak current during the power factor correction is as follows: Model 8505 > 55Apeak Model 8512 > 66Apeak Model 8520 > 90Apeak			•	•

Code	Description	Process to Clear			
		Press EXIT key	Wait 5sec, Press EXIT key	Reboot. If error message repeats contact manufacturer	Contact Manufacturer
PFC_OCP	Displayed when the maximum current during the power factor correction is as follows: Model 8505 > 10Arms Model 8512 > 22Arms Model 8520 > 35Arms			●	●
PFC_OTP	Displayed when the temperature of the DDC side MOS on the PDC board reaches 108°C.			●	●
DD_OVP	Displayed when the output voltage of the DDC board is detected to be greater than 342V.			●	●
DD_LVP	Displayed when the output voltage of the DDC board is detected to be less than 272V.			●	●
DD_OCP	Displayed when the output current of the DDC board is as follows: Model 8505 > 3.35Arms Model 8512 > 6.88Arms Model 8520 > 11.34Arms			●	●
DD_OTP	Displayed when the temperature of the DD side MOS on the DDC board reaches 108°C.			●	●
CALIBRATION ERROR	Displayed when: a. No calibration value is detected. b. An error occurs during the calibration process.	●			
P-Hi	Displayed when the value of real power (W) exceeds the P-Hi setting.	●			
P-Lo	Displayed when the value of real power stays below the P-Lo setting	●			
AP-Hi	Displayed when the peak current value exceeds the AP-Hi setting.	●			
AP-Lo	Displayed when the peak current value stays below the AP-Lo setting.	●			
PF-Hi	Displayed when the power factor value exceeds the PF-Hi setting.	●			
PF-Lo	Displayed when the power factor value stays below the PF-Lo setting.	●			

Code	Description	Process to Clear			
		Press EXIT key	Wait 5sec, Press EXIT key	Reboot. If error message repeats contact manufacturer	Contact Manufacturer
Q-Hi	Displayed when the reactive power value exceeds the Q-Hi setting.	●			
Q-Lo	Displayed when the reactive power value stays below the Q-Lo setting.	●			
CF-Hi	Displayed when the crest factor value exceeds the CF-Hi setting.	●			
CF-Lo	Displayed when the crest factor value stays below the CF-Lo setting.	●			
VA-Hi	Displayed when the apparent power value exceeds the VA-Hi setting.	●			
VA-Lo	Displayed when the value of real power (W) exceeds the P-Hi setting.	●			
Interlock Open	Displayed when the remote interlock key is not plugged into the Signal Input port on the rear panel and the test button is pressed.	Make sure the Remote Safety Interlock key is plugged into the rear panel Signal Input port.			

6. Remote PLC

Two 9-pin “D” type connectors mounted on the rear panel provide input signals and output information for remote control.

Signal Output

The rear panel Signal Output connector of the APT 8500 Series provides output signals to remotely monitor PASS, FAIL, and PROCESSING conditions via a 9-Pin D-type connector. When a terminal becomes active the relay closes thereby allowing the external voltage to operate an external device. These are normally open free contacts and will not provide any voltage or current. The ratings of the contacts are 125 VAC / 1 Amp (30 VDC / 0.5 Amp).

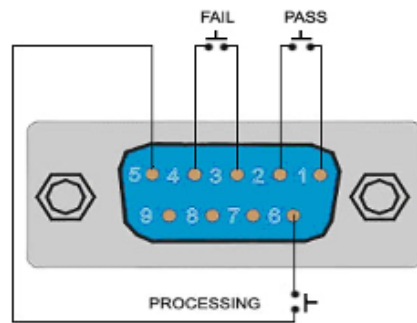

The following table provides the conditions of each pin and the relay state:

Condition	Pins	Relay State
PASS	Connection between PIN 1 & PIN 2	Closes on PASS and is opened on next test initialized.
FAIL	Connection between PIN 3 & PIN 4	Closes on FAIL and is opened when next test is initialized.
PROCESSING	Connection between PIN 5 & PIN 6	Closes when test initialized and opens after test is completed.

Signal Input

The rear panel Signal Input connector of the APT 8500 Series can be used to control any test operation via remote. The 9-Pin D-Type connector enables remote operation for OUTPUT, RESET, Remote Interlock, File Recall and Trigger functions. Remote functions will be activated once the PLC Remote parameter from the System menu is turned on. When the PLC Remote parameter is turned on, you are not able to initiate a test from the front panel OUTPUT/RESET Key. However, when there is an abnormal output detected you can reset by pressing either the OUTPUT/RESET key or through the PLC remote.

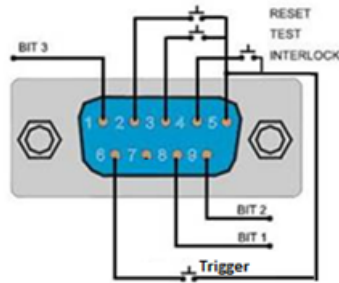

The following table provides the conditions of each pin and the relay state:

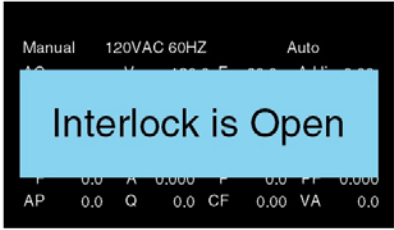
Condition	Pins	Relay State
OUTPUT	Connection between PIN 3 & PIN 5	Momentary contact closure
RESET	Connection between PIN 2 & PIN 5	Momentary contact closure
INTERLOCK	Connection between PIN 4 & PIN 5	<p>Remote Interlock utilizes a set of closed contacts to enable the instrument's output. The output of the instrument will be disabled under the following conditions:</p> <ul style="list-style-type: none"> • If the Interlock contacts are open and the OUTPUT/RESET key is pushed • If the interlock contacts are opened during a test (test will automatically abort) A pop up message will be displayed. 
Trigger	Connection between PIN 5 & PIN 6	Momentary contact closure
Note – Pins 5 & 7 are Common/Ground		

Memory Input Control

Selection of up to 7 test file locations is achieved by using a Normally Open (N.O) Momentary Button. The truth table below provides the pin locations needed in order to select the memories.

File Location	PIN 1	PIN 9	PIN 8
M1	OFF	OFF	ON
M2	OFF	ON	OFF
M3	OFF	ON	ON
M4	ON	OFF	OFF
M5	ON	OFF	ON
M6	ON	ON	OFF
M7	ON	ON	ON

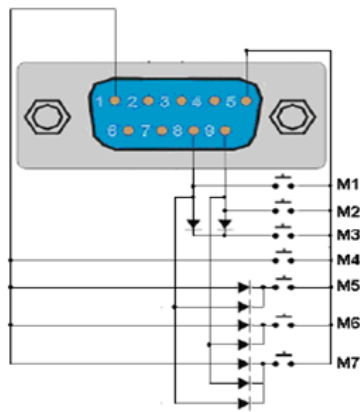

7. Bus Remote Interface USB/LAN/GPIB (Programmable Option Only)

This section provides information on the proper use and configuration of bus remote interface. The USB and LAN interfaces are standard on 8500 series models, an optional GPIB (IEEE-488) interface is also available. Please refer to Section 10 Options of this manual for details on the 8500 series options.

The USB Type B interface requires the user to download a driver in order for the instrument to recognize the USB interface. The driver can be found on the Associated Power Technologies website:

www.aptsources.com/instrument-drivers/

Click on the “Instrument Drivers” link above to start the driver download. This link contains an automatic extract and install program. Follow the instructions of the installation program to initialize the driver install. NOTE: The USB port acts as a USB to RS-232 converter using an FTDI chip. As a result, the PC will recognize the USB port as a virtual COM port.

The USB and LAN interfaces use some of the same command set as the GPIB interface for setting of power source parameters. However there are many functions of the GPIB 488.2 interface that are not available through USB or Ethernet. The IEEE-488 interface included with the 8500 series conforms to the requirements of the IEEE-488.2 standard.

USB and LAN Interface

The USB and LAN interface provides all of the control commands and parameter setting commands of the GPIB interface with the exception of the 488.2 Common Commands, Status Reporting Commands, and SRQ capability. The identification command *IDN? is also available through USB/LAN.

7.1 USB Communication Port Configuration

The USB COM port should have the following configuration:

- 115000 baud (User adjustable using the front panel)
- 8 data bits
- No polarity
- 1 stop bit

This interface does not support XON/XOFF protocol and any hardware handshaking. The controller should be configured to ignore the Handshaking Lines DTR (PIN 4), DSR (PIN 6) and RTS (PIN 9). If the port cannot be configured through software to ignore the lines, the handshaking lines should then be jumped together in two different sets. The PIN 4 and 6 should be jumped together while PIN 7 & 8 should be jumped together at the controller end of the cable.

7.2 LAN Configuration

Default Settings

The default settings for the Ethernet interface are as follows:

IP Setup: AUTO
IP Address: 010.000.000.000
Mask Addr: 255.000.000.000
Gateway Addr: 000.000.000.000

The communication port for the TCP on LAN connections is 10001.

Manual setup of LAN configurations is also available. The LAN Config parameter can be accessed from the second page of the System menu.

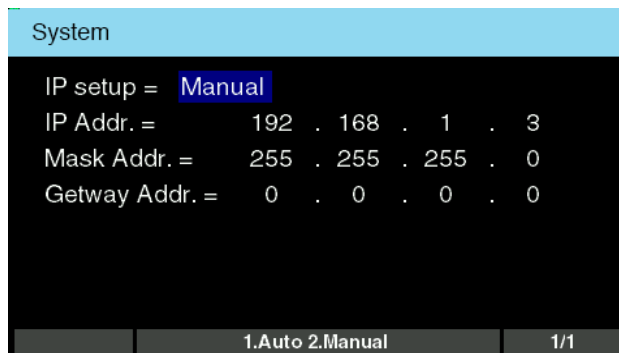

7.3 SCPI (Standard Commands for Programmable Instruments) Basics

This section describes how SCPI information is organized and presented in this manual. An overview of the SCPI language is also provided.

SCPI (Standard Commands for Programmable Instrument) is an ASCII based programming language standard for controlling instruments. SCPI commands consists of configuration and query commands that are specific to the instrument. SCPI commands also includes a set of IEEE 488.2 Operations and Commands that are common between SCPI compatible instruments. SCPI commands syntax can have long and short forms, the long form contains the full command the short form is an abbreviation. For example:

“OUTPut:VOLTage” can be abbreviated to “OUTP:VOLT”.

A valid command syntax is made up of a keyword prefixed with colon “:”. This keyword is then followed by parameters. The following is an example of command syntax:

“OUTPut:CURRent[:LIMit]:HIGH <numeric_value>”

or

“OUTP:CURR:LIM:HIGH 10” which is short form of the command with “10” as the numeric value for the test parameter.

Special Characters in Command

Character	Meaning	Example
	A vertical bar between keywords indicates alternative choices between parameters.	<p>OUTPut:MODE MANual LIST PULSe STEP</p> <p>MANual, LIST, PULe or STEP are the choices</p>
[]	Square brackets indicate an optional keyword. These implied keywords will execute even if they are omitted.	<p>OUTPut:CURRent[:LIMit]:HIGH <numeric_value></p> <p>LIMIt is an optional item.</p>
<>	Angle brackets around a word indicates they are to substituted with proposed parameters.	<p>OUTPut:CURRent[:LIMit]:HIGH <numeric_value></p> <p>In this command, <numeric_value> should be replaced by the actual high limit for output current.</p>

Some SCPI commands exist as both set commands and query commands. An example is an power source output mode command OUTPut:MODE. This command can be used to both set the output mode by using OUTPut:MODE MANual, and query the current state by sending OUTPut:MODE? query. The instrument will return one of the following response MANual , LIST, PULSe, STEP.

7.4 SCPI Command TREE

Program Commands and Companion Queries

These commands are used to modify individual test parameters within each file and/or sequence. Many of these commands require a parameter value to be included with the command. The companion query command will read the parameter. The writing of the parameter requires that the unit not be included with the value and only the numeric value should be included with the command. Also, when the query commands are sent, the response will not include the unit characters.

7.4.1 - Output Subsystem

BASE	KEYWORD	DESCRIPTION	VALUE
OUTPut	:[STATe] <value> :[STATe]?	Set Output State	ON, OFF
	:MODE <value> :MODE?	Set Output Mode	MANual, LIST, PULSe, STEP
	:VOLTage:AC <value> :VOLTage:AC?	Set AC Voltage	0.0 – 310.0 VAC
	:VOLTage:DC <value> :VOLTage:DC?	Set DC Voltage	0.0 – 420.0 VDC
	:FREQuency <value> :FREQuency?	Set Frequency	5.0 – 1200 Hz
	:CURRent[:LIMit]:HIGH <value> :CURRent[:LIMit]:HIGH?	Set Current High Limit	0.05 – 12.50 A*, 0 = OFF
	:PROTection:STATe?	Query Protection State	FAN_FAIL, SOFT_S, OPP, OCP, OVP, OPP_PEAK, OCP_PEAK, OVP_PEAK, INT_TEST_FAIL, CALIBRATION_ERROR, Limit_Fail, DD_OCP, DD_UVP, MCU_FAIL, DA_OTP, PFC_OVP, AC_LVP, AC_OVP, SET_FAIL, OUTPUT_SHORT, RCP, RCP_PEAK, DD_FAIL
	:PROTection:CLEar	Clear Protection State	

7.4.2 Measure Subsystem

BASE	KEYWORD	DESCRIPTION	VALUE
MEASure	:ALL?	Query Meter Data	Voltage, Vac voltage, Vdc voltage, Current, AC current, DC current, Frequency, Power, Pfactor, APEAK, Reactive, Cresfactor, Apparent
	:STATe?	Query Measurement State	OFF, ON, TRIG TO TEST, Ramp Up , Ramp Down , OVP_PEAK , OCP_PEAK , OPP_PEAK , OVP , OCP , OPP , FAN_FAIL , DA_OTP , MCU_FAIL , DD_OVP , DD_LVP , DD_OCP , CALIBRATION_ERROR , INT_TEST_FAIL , DD_FAIL , RCP_PEAK , RCP , UTPUT_SHORT , SET_FAIL , AC_OVP , AC_LVP, PFC_OVP, PFC_LVP, PFC_OCP, PFC_OTP, DD_OTP, VSENSE_INT_OVP, VSENSE_INT_LVP, VSENSE_EXT_OVP, VSENSE_EXT_LVP, A-Hi, A-Lo, P-Hi, P-Lo, VA-Hi, VA-Lo, Q-Hi, PF-Hi, PF-Lo, CF-Hi, CF-Lo, AP-Hi, AP-Lo
	:TIMe[:DWEll]?	Query Dwell Time	1.0 – 999.9
	:COUNt?	Query Count	0 – 50000, 0 = Continuous
	:SEQuence?	Query Sequence Number	0 – 50000, 0 = Continuous
	:VOLTage?	Query Voltage (AC+DC) Meter	
	:VOLTage:AC?	Query AC Voltage	0.0 – 310.0 VAC
	:VOLTage:DC?	Query DC Voltage	0.0 – 420.0 VDC
	:FREQuency?	Query Frequency	5 – 1200 Hz
	:CURRent?	Query Current (AC+DC)	
	:CURRent:AC?	Query AC Current	* See Specification Table
	:CURRent:DC?	Query DC Current	* See Specification Table
	:POWer?	Query Power	
	:PFACtor?	Query Power Factor	
	:APEAK?	Query Peak Current	
	:REACtive	Query Reactive Current	
	:CREStfactor?	Query Crest Factor	
	:APParent	Query Apparent Power	

7.4.3 Mode and File Subsystem

A) Manual Mode Commands and Companion Queries

These commands are used to modify test parameters for the Manual mode on the instrument. The operating mode of the unit should be put in Manual mode for the commands below to work successfully. These commands require a parameter value to be included with the command. The companion query command will read the parameter using the same value that is used for setting the parameter.

BASE	KEYWORD	DESCRIPTION	VALUE
MANual	:FILE:ADD "<file_name>"	Add File	0-9, A – Z, Limit 23 characters for filename.
	:FILE:EDIT OPEN "<file_name>" :FILE:EDIT OPEN?	Edit or Open File Query Filename	
	:FILE:COpy "<file_source>",<file_destination>	Copy File	
	:FILE:LOAD "<file_name>"	Load a File	
	:FILE:DELeTe "<file_name>"	Delete File	0.0 – 420.0 VDC
	:FILE:TOTal?	Query File Total	
	:FILE:INDex <value> :FILE:INDex?	Set File Index	
	:FILE:NAME?	Query File Name	
	:COUPle <value> :COUPle?	Set Coupling Mode	AC, DC, ACDC
	:WAVE :WAVE?	Set Output Waveform	SINE, TRiangle, SQUare, CLIPped
	:THD <value> :THD?	Set THD Value	*Clipped wave only
	:RANGe :RANGe?	Set Voltage Range	AUTO, HIGH, LOW
	:VOLTage:AC <value> :VOLTage:AC?	Set Output AC Voltage	0.0 – 310.0 VAC
	:VOLTage:DC <value> :VOLTage:DC?	Set Output DC Voltage	0.0 – 420.0 VDC
	:FREQuency :FREQuency?	Set Frequency	5 – 1200 Hz
	:RAMP:UP <value> :RAMP:UP?	Set Ramp Up	0.1 – 999.9s, 0 = OFF
	:CURRent[:LIMit]:HIGH <value> :CURRent[:LIMit]:HIGH?	Set Current High Limit	* See Specifications
	:CURRent[:LIMit]:DELaY <value> :CURRent[:LIMit]:DELaY?	Set Delay	* See Specifications
	:POWer[:LIMit]:HIGH <value> :POWer[:LIMit]:HIGH?	Set Power High Limit	* See Specifications
	:ANGLE[:STARt] <value> :ANGLE[:STARt]?	Set Start Angle	0 – 359°

B) List Mode Commands and Companion Queries

These commands are used to modify test parameters for the Manual mode on the instrument. The operating mode of the unit should be put in Manual mode for the commands below to work successfully. These commands require a parameter value to be included with the command. The companion query command will read the parameter using the same value that is used for setting the parameter.

BASE	KEYWORD	DESCRIPTION	VALUE
LIST	:FILE:ADD "<file_name>"	Add File	0-9, A – Z, Limit 23 characters for filename.
	:FILE:EDIT OPEN "<file_name>" :FILE:EDIT OPEN?	Edit or Open File	
	FILE:LOAD "<file_name>" :FILE:LOAD?	Copy File	
	:FILE:COPY "<file_source>",<file_destination>	Copy File	
	:FILE:DELeTe "<file_name>"	Delete File	
	:FILE:TOTAl?	Query File Total	
	:FILE:INDEx <value> :FILE:INDEx?	Set File Index	<value> = Numeric index number
	:FILE:NAME?	Query File Name	
LIST	:PROGram:COUNT :PROGram:COUNT?	Count	0 – 50000, 0 = Continuous
	:PROGram:TRIGger <value> :PROGram:TRIGger?	Set Trigger Mode	AUTO, MANUal
	:PROGram:BASE <value> :PROGram:BASE?	Set Base Value	TIME, CYCLe
	:PROGram:RANGe <value> :PROGram:RANGe?	Set Voltage Range	AUTO, HIGH, LOW
	:PROGram:VOLTage:AC <value> :PROGram:VOLTage:AC?	Set Output AC Voltage	0.0 – 310.0 VAC
	:PROGram:VOLTage:DC <value> :PROGram:VOLTage:DC?	Set Output DC Voltage	0.0 – 420.0 VDC
	:PROGram:FREQUency :PROGram:FREQUency?	Set Frequency	5 – 1200 Hz
	:PROGram:ANGLE:CONTInue <value> :PROGram:ANGLE:CONTInue?	Set Angle Continue	ON, OFF
	:PROGram:FAILStop <value> :PROGram:FAILStop?	Set Fail Stop	ON, OFF
	:SEQUence:ADD	Add Sequence	
	:SEQUence:EDIT OPEN <value> :SEQUence:EDIT OPEN?	Edit or Open Sequence	<value> = Numeric index number

BASE	KEYWORD	DESCRIPTION	VALUE
LIST	:SEquence:COpy <value>	Copy Sequence	<value> = Numeric index number
	:SEquence:DELeTe <value>	Delete Sequence	<value> = Numeric sequence number
	:SEquence:TOtal?	Query Sequence Total	
	:SEquence:WAVE :SEquence:WAVE?	Set Output Waveform	SINE, TRIangle, SQUare, CLIPped
	:SEquence:THD <value> :SEquence:THD?	Set THD Value	*Clipped wave only
	:SEquence:ANGLe[:STARt] :SEquence:ANGLe[:STARt]?	Set Start Angle	0 – 359°
	:SEquence:VOlTage:AC:STARt <value> :SEquence:VOlTage:AC:STARt?	Set Output Start AC Voltage	0.0 – 310.0 VAC
	:SEquence:VOlTage:AC:END <value> :SEquence:VOlTage:AC:END?	Set Output End AC Voltage	0.0 – 310.0 VAC
	SEquence:VOlTage:DC:STARt <value> :SEquence:VOlTage:DC:STARt?	Set Output Start DC Voltage	0.0 – 420.0 VDC
	:SEquence:VOlTage:DC:END <value> :SEquence:VOlTage:DC:END?	Set Output End DC Voltage	0.0 – 420.0 VAC
	:SEquence:FREQUency:STARt <value> :SEquence:FREQUency;STARt?	Set Output Start Frequency	5 – 1200 Hz
	:SEquence:FREQUency:END <value> :SEquence:FREQUency;END?	Set Output End Frequency	5 – 1200 Hz
	:SEquence:TIME[:DWEll] <value> :SEquence:TIME[:DWEll]?	Set Dwell Time	1.0 – 999.9
	:SEquence:TIME:UNIT <value> :SEquence:TIME:UNIT?	Set Time Unit	HOUR, MINute, SECond, MS
	:SEquence:CYCLe :SEquence:CYCLe?	Set Cycle	Active when Base = Cycle, 0-9999
	:SEquence:CURRent[:LIMit]:HIGH :SEquence:CURRent[:LIMit]:HIGH?	Set Current High Limit	0.05 – 12.50 A, 0 = OFF* See Specs
	:SEquence:CURRent[:LIMit]:LOW :SEquence:CURRent[:LIMit]:LOW?	Set Current Low Limit	0.05 – 12.50 A, 0 = OFF* See Specs
	:SEquence:CURRent[:LIMit]:Delay :SEquence:CURRent[:LIMit]:Delay	Set Current Hi-Limit Delay	0.0 - 999.9

BASE	KEYWORD	DESCRIPTION	VALUE
	:SEquence:POWer[:LIMit]:HIGH :SEquence:POWer[:LIMit]:HIGH?	Set Power High Limit	0 – 1250 W, 0 = OFF* See Specs
	:SEquence:POWer[:LIMit]:LOW :SEquence:POWer[:LIMit]:LOW?	Set Power Low Limit	0 – 1250 W, 0 = OFF* See Specs
	:SEquence:PFACtor[:LIMit]:HIGH :SEquence:PFACtor[:LIMit]:HIGH?	Set Power Factor High Limit	0.000 – 1.000, 0 = OFF
	:SEquence:PFACtor[:LIMit]:LOW :SEquence:PFACtor[:LIMit]:LOW?	Set Power Factor Low Limit	0.000 – 1.000, 0 = OFF
	:SEquence:APEAK[:LIMit]:HIGH :SEquence:APEAK[:LIMit]:HIGH?	Set Peak Amps High Limit	0.0 – 50.0 A, 0 = OFF* See Specs
	:SEquence:APEAK[:LIMit]:LOW :SEquence:APEAK[:LIMit]:LOW?	Set Peak Amps Low Limit	0.0 – 50.0 A, 0 = OFF* See Specs
	:SEquence:REACtive[:LIMit]:HIGH :SEquence:REACtive[:LIMit]:HIGH?	Set Reactive Power High Limit	0 – 1250 VAR, 0 = OFF* See Specs
	SEquence:REACtive[:LIMit]:LOW :SEquence:REACtive[:LIMit]:LOW?	Set Reactive Power Low Limit	0 – 1250 VAR, 0 = OFF* See Specs

BASE	KEYWORD	DESCRIPTION	VALUE
	:SEquence:CREStfactor[:LIMit]:HIGH :SEquence:CREStfactor[:LIMit]:HIGH?	Set Crest Factor High Limit	0.00 – 10.00, 0 = OFF
	:SEquence:CREStfactor[:LIMit]:LOW :SEquence:CREStfactor[:LIMit]:LOW?	Set Crest Factor Low Limit	0.00 – 10.00, 0 = OFF
	:SEquence:APParent[:LIMit]:HIGH :SEquence:APParent[:LIMit]:HIGH?	Set Apparent Power High Limit	0 – 1250 VA, 0 = OFF* See Specs
	:SEquence:APParent[:LIMit]:LOW :SEquence:APParent[:LIMit]:LOW?	Set Apparent Low Limit	0 – 1250 VA, 0 = OFF* See Specs

C) Step Mode Commands and Companion Queries

These commands are used to modify test parameters for the Step mode on the instrument. The operating mode of the unit should be put in Step mode for the commands below to work successfully. These commands require a parameter value to be included with the command. The companion query command will read the parameter using the same value that is used for setting the parameter.

BASE	KEYWORD	DESCRIPTION	VALUE
STEP	:FILE:ADD "<file_name>"	Add File	0-9, A – Z, Limit 23 characters for filename.
	:FILE:EDIT OPEN "<file_name>" :EDIT OPEN?	Edit or Open File	
	:FILE:LOAD "<file_name>" :LOAD?	Load a File	
	:FILE:COpy "<file_source>",<file_destination>	Copy File	
	:FILE:DELeTe "<file_name>"	Delete File	
	:FILE:TOTal?	Query File Total	
	:FILE:INDEx <value> :FILE:INDEx?	Set File Index	
	:FILE:NAME?	Query File Name	
	:COUNT :COUNT?	Count	0 – 50000, 0 = Continuous
	:TRIGger <value> :TRIGger?	Set Trigger Mode	AUTO, MANUal
	:BASE <value> :BASE?	Set Base Value	TIME, CYCLe
	:RANGe <value> :RANGe?	Set Voltage Range	AUTO, HIGH, LOW
	:WAVE :WAVE?	Set Output Waveform	SINE, TRIangle, SQUare, CLIPped
	:THD <value> :THD?	Set THD Value	* Clipped wave only

BASE	KEYWORD	DESCRIPTION	VALUE
	:ANGLE[:START] :ANGLE[:START]?	Set Start Angle	0 – 359°
	:VOLTage:AC <value> :VOLTage:AC?	Set Output AC Voltage	0.0 – 310.0 VAC
	:VOLTage:DC <value> :VOLTage:DC?	Set Output DC Voltage	0.0 – 420.0 VDC
	:FREQuency :FREQuency?	Set Frequency	5 – 1200 Hz
	:TIME[:DWEll] <value> :TIME[:DWEll]?	Set Dwell Time	0.0 – 999.9
	:TIME:UNIT <value> :TIME:UNIT?	Set Time Unit	HOUR, MINute, SECond, MS
	:CYCLe :CYCLe?	Set Cycle	1-9999
	:DELTA:VOLTage:AC :DELTA:VOLTage:AC?	Set Range of Change in Volts AC	0.0 – 310.0
	:DELTA:VOLTage:DC :DELTA:VOLTage:DC?	Set Time Unit	HOUR, MINute, SECond, MS
	:DELTA:FREQuency :DELTA:FREQuency?	Set Range of Change of Frequency	0.0 – 1200

D) Pulse Mode Commands and Companion Queries

These commands are used to modify test parameters for the Pulse mode on the instrument. The operating mode of the unit should be put in Pulse mode for the commands below to work successfully. These commands require a parameter value to be included with the command. The companion query command will read the parameter using the same value that is used for setting the parameter.

BASE	KEYWORD	DESCRIPTION	VALUE
PULSe	:FILE:ADD "<file_name>"	Add File	0-9, A – Z, Limit 23 characters for filename.
	:FILE:EDIT OPEN "<file_name>" :FILE:EDIT OPEN?	Edit or Open File	
	FILE:LOAD <file_name> :FILE:LOAD?	Load a File	
	:FILE:COpy "<file_source>",<file_destination>	Copy File	
	:FILE:DELeTe "<file_name>"	Delete File	

BASE	KEYWORD	DESCRIPTION	VALUE
	:FILE:TOTal?	Query File Total	
	:FILE:INDex <value> :FILE:INDex?	Query File Index	
	:FILE:INDex?	Set File Index	
	:FILE:NAME?	Query File Name	
	:COUNT :COUNT?	Count	0 – 50000, 0 = OFF
	:TRIGger <value> :TRIGger?	Set Trigger Mode	AUTo, MANual
	:RANGe <value> :RANGe?	Set Voltage Range	AUTo, HIGH
	:ANGLE[:START] :ANGLE[:START]?	Set Start Angle	0 – 359°
	:VOLTage:AC <value> :VOLTage:AC?	Set Output AC Voltage	0.0 – 310.0 VAC
	:VOLTage:DC <value> :VOLTage:DC?	Set Output DC Voltage	0.0 – 420.0 VDC
	:FREQuency: <value> :FREQuency?	Set Frequency	5 – 1200 Hz
	:TRANSient:AC <value> :TRANSient:AC?	Set Transient AC Voltage	0.0 - 310.0 VAC
	:TRANSient:DC <value> :TRANSient:DC	Set Transient DC Voltage	0.0 – 420.0 VDC
	:DUTY <value> :DUTY?	Set Duty Value	0 – 100 %
	:PERiod <value> :PERiod?	Count	0 – 50000, 0 = OFF

7.4.4 Meter Subsystem

Meter Selection Commands and Companion Queries

These commands are used to select the displayed meter on the front LCD display. The secondary meter will be set to the selected meter by the command below. These commands require a parameter value to be included with the command. The companion query command will read the parameter using the same value that is used for setting the parameter.

BASE	KEYWORD	DESCRIPTION	VALUE
	METer <value> METer?	Select Meter	FREQuency, CURRent, POWer, PFACtor, APEAK, REACtive, CRESfactor, APParent, VAC, VDC, AAC, ADC

7.4.5 Result Subsystem

Result Queries

These commands are used to query results data from the instrument. The query command will read the parameter that is stored for each Sequence in the List Mode operation. For other output modes, use MEASURE Subsystem commands to query live data while the unit is outputting.

BASE	KEYWORD	DESCRIPTION	VALUE
RESult	:SEQuence <value> :SEQuence?	Select Sequence Number	
	:STATe?	Query State	OFF, ON, TRIG TO TEST, Ramp Up, Ramp Down, OVP_PEAK, OCP_PEAK, OPP_PEAK, OVP, OCP, OPP, FAN_FAIL, DA_OTP, MCU_FAIL, DD_OVP, DD_LVP, DD_OCP, CALIBRATION_ERROR, INT_TEST_FAIL, DD_FAIL, RCP_PEAK, RCP, UTPUT_SHORT, SET_FAIL, AC_OVP, AC_LVP, PFC_OVP, PFC_LVP, PFC_OCP, PFC_OTP, DD_OTP, VSENSE_INT_OVP, VSENSE_INT_LVP, VSENSE_EXT_OVP, VSENSE_EXT_LVP, A-Hi, A-Lo, P-Hi, P-Lo, VA-Hi, VA-Lo, Q-Hi, PF-Hi, PF-Lo, CF-Hi, CF-Lo, AP-Hi, AP-Lo
	:TOTal?	Query Total Results Available	
	:ALL?	Query Meter Data	Voltage, Vac voltage, Vdc voltage, Current, AC current, DC current, Frequency, Power, Pfactor, APEAK, Reactive, Crestfactor, Apparent
	:VOLTage:AC?	Query AC Voltage	0.0 – 310,0 VAC
	:VOLTage:DC?	Query DC Voltage	0.0 – 420.0 VDC
	:VOLTage:STARt?	Query Start Voltage	-
	:VOLTage:END?	Query End Voltage	-
	:FREQuency?	Query Frequency	5.0 – 1200 Hz
	:CURRent:AC?	Query AC Current	* See Specifications
	:CURRent:DC?	Query DC Current	* See Specifications
	:POWer?	Query Power	* See Specifications
	:PFACtor?	Query PFACtor	0.000 – 1,000
	:APEAK?	Query Amps Peak	0.0 – 50.0 A
	:REACtive?	Query Reactive Power	* See Specifications

BASE	KEYWORD	DESCRIPTION	VALUE
	:CREStfactor?	Query Crest Factor	0.0 – 10.00
	:APParent?	Query Apparent Power	* See Specifications

7.4.6 System Subsystem

System Commands and Companion Queries

These commands are used to modify the system parameters for the instrument. The parameters below control the global system parameter that applies in all Output Modes of this power supply. These commands require a parameter value to be included with the command. The companion query command will read the parameter using the same value that is used for setting the parameter.

BASE	KEYWORD	DESCRIPTION	VALUE
SYSTem	:PLC[:REMOte] <value> :PLC[REMOte]?	Set PLC	0, 1, ON, OFF
	:POWUP <value> :POWUP?	Set Power Up State	OFF, ON, LAST
	:ALARm <value> :ALARm?	Alarm Volume	0 – 9, 0 = OFF
	:OCFold <value> :OCFold?	Set OCFold Back	0, 1, ON, OFF
	:SENSe[:VOLTage] <value> :SENSe[:VOLTage]?	Set Voltage Sense	INTernal, EXTernal
	:SYNChronous[:SIGNal] <value> :SYNChronous[:SIGNal]?	Set SYNC Signal	START, END, BOTH, OFF, ON, EVENT
	[:LIMit]:VOLTage:AC:HIGH <value> [:LIMit]:VOLTage:AC:HIGH?	Set System AC Voltage High Limit	0.0 – 310.0 VAC
	[:LIMit]:VOLTage:AC:LOW <value> [:LIMit]:VOLTage:AC:LOW?	Set System AC Voltage Low Limit	0.0 – 310.0 VAC
	[:LIMit]:VOLTage:DC:HIGH <value> [:LIMit]:VOLTage:DC:HIGH?	Set System DC Voltage High Limit	0.0 – 420.0 VDC
	[:LIMit]:VOLTage:DC:LOW <value> [:LIMit]:VOLTage:DC:LOW?	Set System DC Voltage Low Limit	0.0 – 420.0 VDC
	[:LIMit]:FREQuency:HIGH <value> [:LIMit]:FREQuency:HIGH?	Set System Frequency High Limit	5.0 – 1200 Hz
	[:LIMit]:FREQuency:LOW <value> [:LIMit]:FREQuency:LOW?	Set System Frequency Low Limit	5.0 – 1200 Hz
	:LOCK <value> :LOCK?	Set Lock	0, 1, ON, OFF
	:GPIB <value> :GPIB?	Set GPIB Address	
	:LAN:ADDReSS :LAN:ADDReSS?	Set IP Address	
	:MAC?	Query MAC ID	

Execution Time Restrictions

The following commands require a higher amount of processing time which may be higher than the rest of the commands list. Allow the listed “Execute Time” as the minimum time in order to successfully execute the command.

COMMAND TIMING LIST	
Command	Execute Time
<normal setting command>	<60ms
<normal query command>	<20ms
MANual:FILE:ADD LIST:FILE:ADD STEP:FILE:ADD PULSe:FILE:ADD	<250ms
MANual:FILE:LOAD LIST:FILE:LOAD STEP:FILE:LOAD PULSe:FILE:LOAD	<300ms
LIST:SEQ:ADD	<80ms
SYSTem[:LIMit]:VOLTage[:AC]:HIGH SYSTem[:LIMit]:VOLTage[:AC]:LOW SYSTem[:LIMit]:VOLTage:DC:HIGH SYSTem[:LIMit]:VOLTage:DC:LOW SYSTem[:LIMit]:FREQuency:HIGH SYSTem[:LIMit]:FREQuency:LOW	<(300ms*file number)
SYSTem:FACTory:DEFault	10s

7.5 GPIB Interface

Connection is usually accomplished with a 24-conductor cable with a plug on one end and a connector at the other end. Devices may be connected in a linear, star or combination configuration.

The standard connector is the Amphenol or Cinch Series 57 Microribbon or AMP CHAMP type. The GPIB uses negative logic with standard transistor-transistor logic (TTL) levels. When DAV is true, for example, it is a TTL low level ($\leq 0/8\text{ V}$), and when DAV is false, it is a TTL high level ($\geq 2.0\text{ V}$).

Restrictions and Limitations on the GPIB

- A maximum separation of 4 m between any two devices and an average separation of 2 m over the entire bus.
- A maximum total cable length of 20 m.
- No more than 15 device loads connected to each bus, with no less than two-thirds powered on. For example 1 GPIB controller and a maximum of 14 GPIB instruments.
- Note: A bus extender, which is available from numerous manufacturers, is available to overcome these limitations.

7.5.1 GPIB Address

Each device on the GPIB (IEEE-488) interface must have a unique address. You can set the address of the 8500 series to any value between 0 and 30. The address can only be set from the front panel. The address is stored in non-volatile memory and does not change when the power has been turned off or after a remote reset.

Note – The GPIB address is set to 8 when the instrument is shipped from the factory.

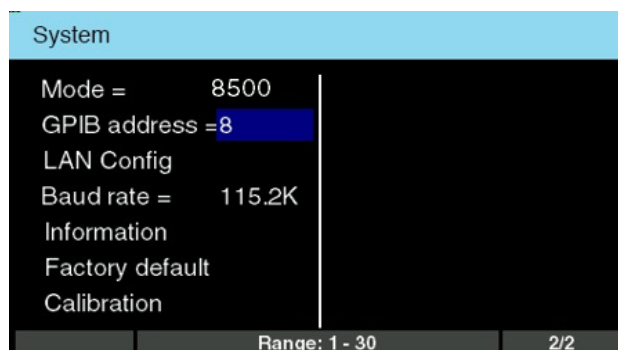

Interface Functions

The capability of a device connected to the bus is specified by its interface functions. These functions provide the means for a device to receive, process, and send messages over the bus. The interface functions are listed in the chart below:

Interface Function	Subset	Description
Source Handshake	SH1	Complete Source handshake capability
Acceptor Handshake	AH1	Complete Acceptor handshake capability
Talker	T6	Talker functions (unaddress if MLA)
Listener	L4	Listener functions (unaddress if MTA)
Service Request	SR1	Complete Service request capability
Remote Local	RL0	No remote/local capability
Parallel Poll	PPO	No parallel poll capability
Device Clear	DC1	Complete Device clear capability
Device Trigger	DT0	No device trigger capability
Controller	C0	No controller capability
Electrical Interface	E2	Three-state drivers

Interface Function	Description
Controllable Items	Test and Reset control.
	Setting of test parameters for tests.
	Reading of instrument status and test results.
Data Codes	ASCII
Delimiter	NL (+ EOI)

7.6 GPIB/USB/LAN Interface Sample Command List

A GPIB read command must be sent after the command strings, to retrieve any data from a query command (?). The APT 8500 series GPIB bus will not send any data to the controller without being queried. The USB/LAN bus will automatically send any response back to the controller's input buffer. Each command string should be terminated with the ASCII control code, New Line <NL>, OAh or the end of line EOL message for GPIB.

The following conventions are used to describe the commands syntax. Braces ({}) enclose each parameter for a command string. Triangle brackets (< >) indicate that you must substitute a value for the enclosed parameter. The Pipe (|) is used to separate different parameter options for a command. Do not include any of the above characters when sending the commands. The command and the value should be separated with a space. **For a list of All SCPI commands, refer to section 7.4.1- SCPI Tree.**

All commands that end with a question mark (?) are query commands and require an IEEE-488 read command to retrieve the data from the device's output buffer.

7.6.1 Basic Commands and Query Commands

The following commands are used to control actual output voltage and current from the instrument. This command set also includes query commands. These query commands will retrieve data from the instrument. The GPIB bus application requires an IEEE-488 read command to be sent after the query command. These commands include functions for retrieving test data, test results and metering values.

OUTP:STAT ON

Turns on the output voltage at the selected step loaded into memory.

OUTP:STAT OFF

Turns the output voltage off.

OUTP:STAT ON

Turns on the output voltage at the selected step loaded into memory.

OUTP:STAT OFF

Turns the output voltage off.

OUTP:PROT:CLE

Clears the failure message from the instrument in the event of a failure.

MEASure:ALL?

Reads the active data being displayed on the LCD display while the test is in process. This command will also read the last data taken when the test sequence has completed. Each parameter is separated by commas and includes frequency value, voltage value, current value, power value, peak current value, power factor value and timer metering. The syntax for the command response is <V>,<VAC>,<VDC>,<A>,<AAC>,<ADC>,<F>,<P>,<PF>,<AP>,<Q>,<CF>,<VA>. Each meter will contain only the value and not the units. Current and peak current are displayed in amps while power is displayed in Watts.

RESult:ALL?

Reads the results for an individual sequence. The sequence number has to be selected first by sending RESult:Sequence <numerica_value>, this will select the appropriate sequence number. Each results parameter is separated by commas and includes all metering data. The syntax for this command response is <Voltage>,<Vac voltage>,<Vdc voltage>,<Current>,<AC

MEASure:FREQuency?

Reads the active frequency value being displayed while a test is in process.

MEASure:VOLTAge:AC?

MEASure:VOLTAge:DC?

Reads the active voltage value being displayed while a test is in process.

MEASure:CURREnt?

MEASure:CURREnt:AC?

MEASure:CURREnt:DC?

Reads the active current value being displayed while a test is in process.

MEASure:APEAK?

Reads the active peak current value being displayed while a test is in process.

MEASure:POWER?

Reads the active power value being displayed while a test is in process.

MEASure:PFACTor?

Reads the active power factor value being displayed while a test is in process.

MEASure:TIME:DWELI?

Read the active timer meter value being displayed while a test is in process.

METer POWER

Selects the metered value that is displayed while a test is in process. To change meters send a new command with name of the meter from the list below:

FREQuency|CURREnt|POWER|PFACTor|APEAK|REACTIVE|CREStfactor|APPARENT|VAC|VDC|AAC|ADC

METer?

Reads the selected meter value. Returns meter name.

<Current>,<Adccurrent>,<Frequency>,<Power>,<Pfactor>,<APEAK>,<Reactive>,<Crestfactor>,<Apparent> Each meter will contain only the value and not the units.

7.6.2 IEEE 488.2 Common Commands

System Commands and Companion Queries

These commands are required by the IEEE-488.2 standard with the exception of *PSC, *PSC?. Most of these commands are not available over the USB/RS-232 bus except for the *IDN? command which can be used to retrieve the instrument identification information, and the four status reporting commands *ESR?, *ESE, *ESE? and *STB?.

Command	Name	Description
*IDN?	Identification Query	Company, Model Number, Serial Number, Firmware Revision
*RST	Reset Command	Resets Unit
*TST?	Self-Test Query	00H=OK 01H=TEST EEPROM ERROR
*CLS	Clear Status Command	Clear Standard Event Status Register Clear Service Request Register
*OPC	Operation Complete Command	When TEST command ok setting ESR BIT0 =1
*WAI	Wait for next command	
*ESR?	Standard Event Status Register Query	BIT 0 ,01H, (1) Operation Complete
		BIT 1 ,02H, (2) Not Used
		BIT 2 ,04H, (4) Query Error
		BIT 3 ,08H, (8) Device Error
		BIT 4 ,10H,(16) Execution Error
		BIT 5 ,20H,(32) Command Error
		BIT 6 ,40H,(64) Not Used
		BIT 7 ,80H,(128) Power On
*ESE <value>	Standard Event Status Enable Command	value=0~255
*ESE?	Standard Event Status Enable Query	0 - 255
*STB?	Read Status Byte Query	BIT 0 ,01H,(1) All PASS
		BIT 1 ,02H,(2) FAIL
		BIT 2 ,04H,(4) ABORT
		BIT 3 ,08H,(8) Process

Command	Name	Description
		BIT 4, 10H,(16) Message Available
		BIT 5, 20H,(32) Standard Event (ESB)
		BIT 6, 40H,(64) Request Service (MSS)
		BIT 7, 80H,(128) Prompt
*SRE <value>	Service Request Enable	value=0~255
*SRE?	Service Request Enable Query	0 - 255
*PSC { 1 0 }	Power-On Status	1 = Power-on clear enable registers 0 = Power-on load previous enable registers
*PSC?	Power-On Status Query	returns value = 0 or 1

*IDN?

Reads the instrument identification string. Company = APT.

*RST

Resets the instrument to original power on configuration. Does not clear Enable register for Standard Summary Status or Standard Event Registers. Does not clear the output queue. Does not clear the power-on-status-clear flag. The System parameters that are affected by the *RST command are listed in the following table:

Item	Value
OUTPut[:STATe]	OFF
OUTPut:MODE	Manual
MANual:FILE:LOAD	<none>
MANual:FILE:EDIT	<none>
SYSTem:PLC	<default value>
SYSTem:POWUP	<default value>
SYSTem:ALARm	<default value>
SYSTem:OCFold	<default value>
SYSTem:SYNChronous	<default value>
SYSTem:ANALog	<default value>
SYSTem:VOLTage[:AC]:HIGH	<default value>
SYSTem:VOLTage[:AC]:LOW	<default value>
SYSTem:VOLTage:DC:HIGH	<default value>
SYSTem:VOLTage:DC:LOW	<default value>
SYSTem:FREQuency:HIGH	<default value>
SYSTem:FREQuency:LOW	<default value>
METer	<default value>

***TST?**

Performs a self test of the instrument data memory. Returns 0 if it is successful or 1 if the test fails.

***CLS**

Clears the Status Byte summary register and event registers. Does not clear the Enable registers.

***OPC**

Sets the operation complete bit (bit 0) in the Standard Event register after a command is completed successfully.

***OPC?**

Returns an ASCII "1" after the command is executed.

***WAI**

After the command is executed, this prevents the instrument from executing any further query or commands until the no-operation-pending flag is TRUE.

***ESR?**

Queries the Standard Event register. Returns the decimal value of the binary-weighted sum of bits.

***ESE <value>**

Standard Event enable register controls which bits will be logically ORed together to generate the Event Summary bit 5 (ESB) within the Status Byte.

***ESE?**

Queries the Standard Event enable register. Returns the decimal value of the binary-weighted sum of bits.

***STB?**

Reads the Status Byte. Returns the decimal value of the binary-weighted sum of bits.

***SRE <value>**

Service Request enable register controls which bits from the Status Byte should be used to generate a service request when the bit value = 1.

***SRE?**

Queries the Service Request enable register. Returns the decimal value of binary-weighted sum of bits.

***PSC {1|0}**

Sets the power-on status clear bit. When set to 1 the Standard Event Enable register and Status Byte enable registers will be cleared when power is turned ON. The 0 setting indicates the Enable registers will be loaded with Enable register masks from non-volatile memory at power ON.

***PSC?**

Queries the power-on status clear setting. Returns 0 or 1.

7.6.3 Status Subsystem

Operation and Questionable Status Registers

Command Format	STATus:OPERation[:EVENTi]? STATus:CONDition? STATus:OPERation:ENABle <numeric_value>
Description	Operation Status Registers Enable and Query
Example	STATus:CONDition?

Command Format	STATus:OPERation[:EVENTi]? STATus:CONDition? STATus:OPERation:ENABle <numeric_value>
Description	Operation Status Registers Enable and Query
Example	STATus:CONDition?

Item	Name	Value
STAT:OPER:COND?	Operation Status Register Query	BIT 0 ,01H, (1) Reserved
		BIT 1 ,02H, (2) Calibration Mode
		BIT 2 to 15 Reserved
STAT:QUES:COND?	Questionable Status Register Query	BIT 0 ,01H,(1) Reserved
		BIT 1 ,02H,(2) Protection Event
		BIT 2 ,04H,(4) Fatal Error
		BIT 3 ,08H,(8) Calibration Error
		BIT 4 ,10H,(16) Interlock Open
		BIT 5 – 15 Reserved

7.6.3 Status Subsystem

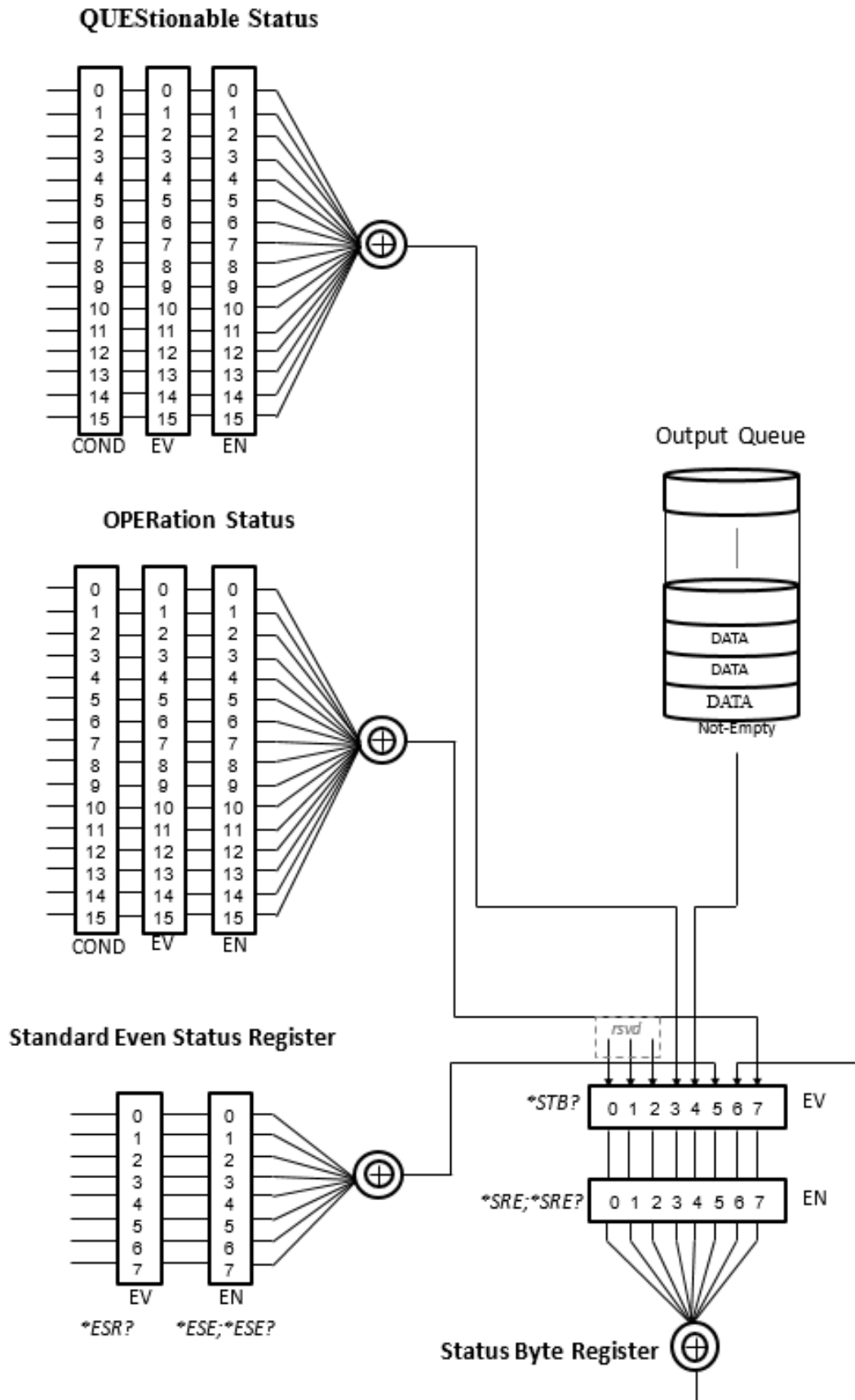

8. Options

This section contains a list and descriptions of available factory installed options. The list of options contains an option code number along with a description of the option:

Option Code	Option Name
01	Programmable
03	GPIB Interface

8.1 Option 01 – Programmable

This option provides programmable capability to the instrument. It enables the standard USB/LAN ports for PC/Software control of the instrument. It also adds the LIST, STEP, and PULSE Modes along with the MANUAL Mode. Additional meters and functions are also available with this option. See Section 3.1 Specifications for details on the available meters and functions with this option.

8.2 Option 03 – GPIB Interface

This option provides the GPIB interface along with the standard USB and LAN interfaces. See Section 7 for more details on GPIB communication.

9. Calibration Procedure

All Associated Power Technologies (APT) instruments have been calibrated at the manufacturing factory prior to delivery. The recommended calibration cycle for all APT instruments is every 12 months.

The following meters and accessories will be required to calibrate this instrument:

- A digital multimeter (DMM) that can handle up to 310VAC and 420VDC.
- A digital voltage meter (DVM) that can be programmed to measure in the mV (milli-Volt) range.
- A digital multimeter (DMM) that can handle up to 40A (see specifications for maximum current outputs of specific models).
- Resistive load 3, 5 and 10 Ohms.

Sections 9.1 through 9.5 describe the calibration procedure for this instrument. All instructions for the user are displayed on the instrument's screen throughout the calibration procedure. It is important to follow all the instructions on the screen in order to successfully calibrate this instrument.

9.1 Enter Calibration Screen

This option provides programmable capability to the instrument. It enables the standard USB/LAN ports for PC/Software control of the instrument. It also adds the LIST, STEP, and PULSE Modes along with the MANUAL Mode. Additional meters and functions are also available with this option. See Section 3.1 Specifications for details on the available meters and functions with this option.

Power on the instrument and press any key or Rotary knob from the default screen to drop down the menu bar.



Press the number 5 key on the keypad to enter the System menu.



Use the rotary knob to view the next page of the System screen.

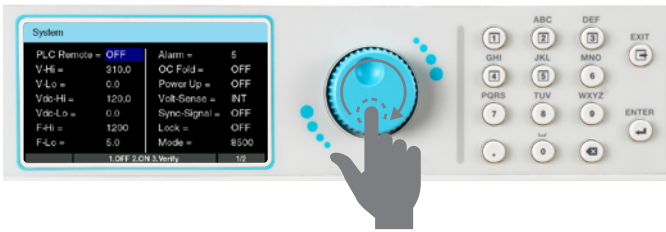

Use the rotary knob to highlight the Calibration selection and press the ENTER key.

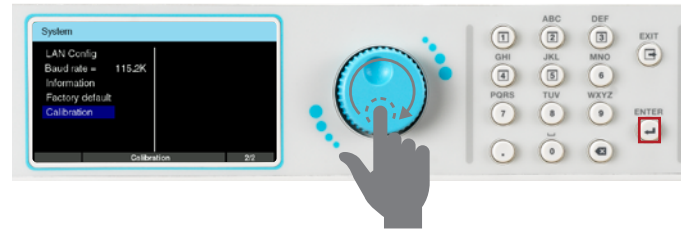

Key in the calibration password 8888 and press the ENTER key.



Calibration main screen will appear. The output and remote sense terminal (L to Ls and N to Ns on the rear panel output terminal lug) must be shorted during the calibration.



9.2 Calibration of Voltage Setting and Measurement (Low Range)

Connect Meter Connect the outputs of APT 85XX to DVM. DVM is adjusted to Vdc measurement.

From the calibration main screen use the rotary knob to highlight Voltage Setting & Measurement (Low Range) selection. Press the ENTER key to view the next page.



Use the rotary knob to highlight 155V Offset Voltage selection. Press the ENTER key to enter the next page.

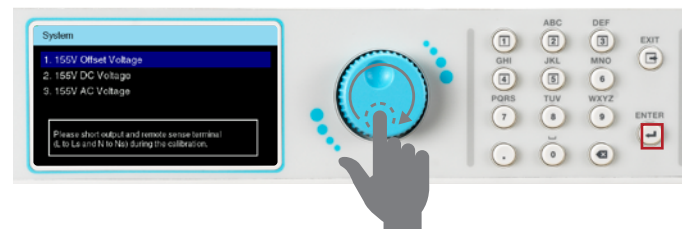

Connect 210VDC voltage meter.



Observe the voltage measurement on the DVM, then input the “negation value” of the measurement (e.g. DVM Vdc= 1234mV, input the value “-1234” , press the . key to enter the +/- symbol).

Do **NOT** press the ENTER key after inputting the value. Dial the rotary knob to adjust the output until the reading of DVM goes down to zero, then press the ENTER key.



The measured value Vdc is already close to zero and this screen will be displayed. Press the 1 key to save the correction value.

Use the rotary knob to highlight the 155V DC Voltage selection. Press the ENTER key to view the next page.

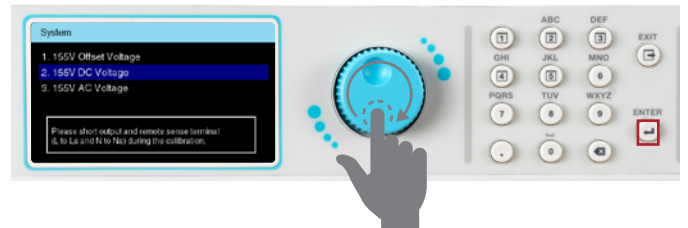

Connect 210VDC voltage meter.

Input the Vdc measurement of the DVM. Press the ENTER key to view the next page.

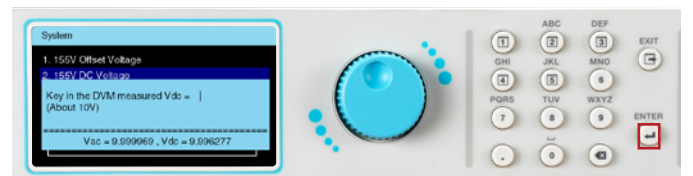

Input the Vdc measurement of the DVM.
Press the ENTER key to enter the next page.



This calibration item has been completed
Press the 1 key to save the correction value.



Adjust Meter DVM is adjusted to Vrms measurement.

Use the rotary knob to highlight 155V AC Voltage selection. Press the ENTER key to enter the next page.

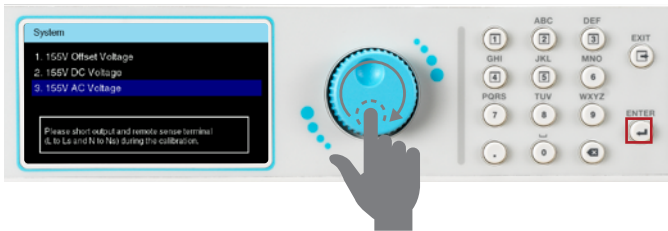

Connect 155VAC voltage meter.



Input the DVM measured Vrms value.
Press the ENTER key to enter the next page.

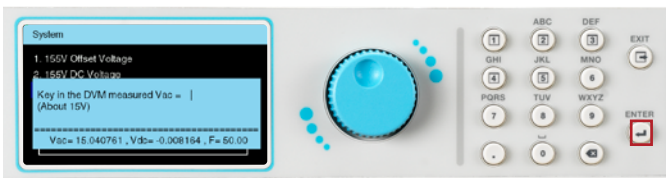

Wait for auto calibration of the voltage setting.



Wait a moment, the frequency setting will automatically change from 50Hz to 1200Hz. (This step does not require any action. This item is the calibration of the AC set value in the frequency range of 50Hz~1200Hz.)

Input the DVM measured Vrms value.
(This item is 500 Hz AC measurement correction).



Input the DVM measured Vrms value.
(This item is 1000 Hz AC measurement correction).

This calibration item has been completed
Press the 1 key to save the correction value.



9.3 Calibration of Voltage Setting and Measurement (High Range)

From the calibration main screen use the rotary knob to highlight the Voltage Setting & Measurement (High Range) selection. This process is the same as Calibration of Voltage Setting & Measurement (Low Range) and will not be explained.

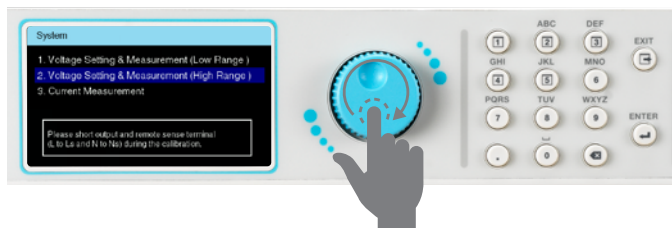

9.4 Calibration of Current Measurement

From the Calibration main screen use the Rotary knob to highlight the Current Measurement selection. Press the ENTER key to enter the next page.

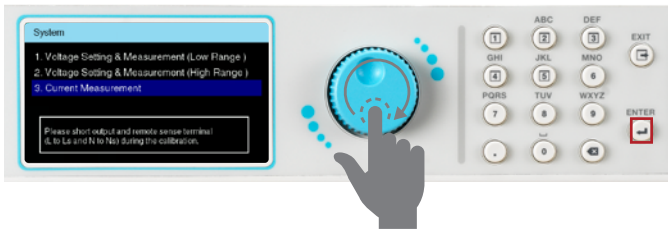

Use the Rotary knob to highlight the Current Offset selection. Press the ENTER key to enter the next page.

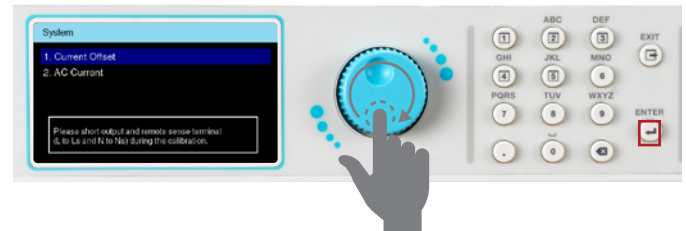

Confirm the output terminal remains open. Press the 1 key to confirm.



The measured value I_{dc} will gradually approach zero.



This calibration item has been completed. Press the 1 key to save the correction value.



Adjust Meter

DMM is adjusted to I_{rms} measurement.

Use the rotary knob to highlight the AC Current selection. Press the ENTER key to view the next page.

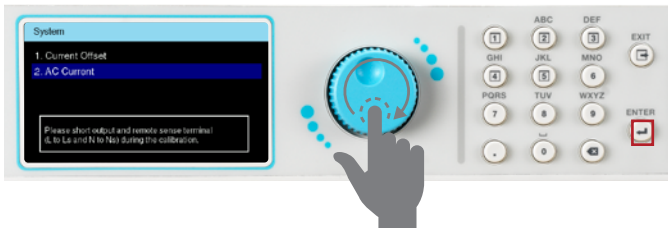

Confirm that there is a connection to the load. Press the 1 key to confirm. Reference the following table for proper resistive load values for each of the four different APT 8500 models:

Model	Amp Meter	Load
8505	5A	10Ω
8512	12.5A	10Ω
8520	20A	5Ω
8540	40A	3Ω



Observe the RMS reading of AC current meter.



Observe the RMS reading of AC current meter (high range).



This calibration item has been completed
Press the 1 key to save the correction value.

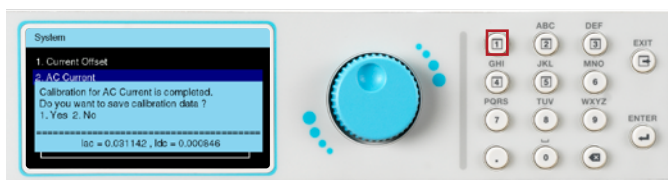

9.5 View Calibration Data

After the calibration is completed successfully the user can view the calibration data.

Access the calibration selection from the System menu and enter password 8080 to view calibration data.



Use the rotary knob to view page 1 of calibration data.

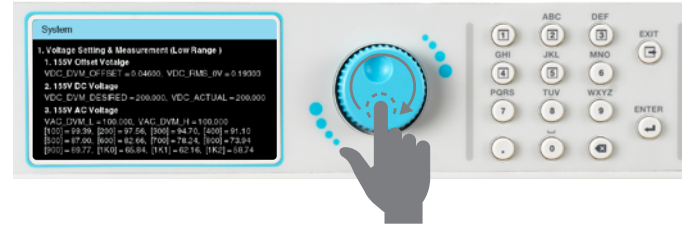

Use the rotary knob to view page 2 of calibration data.

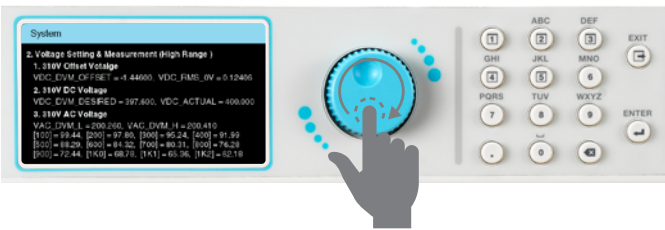

Use the rotary knob to view page 3 of calibration data.

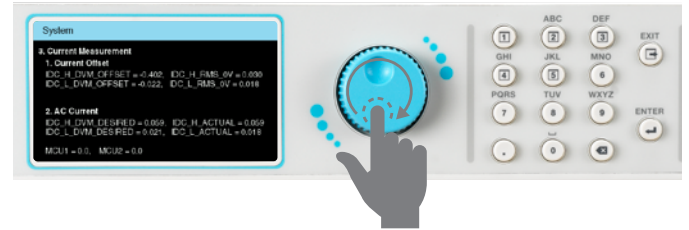

10. Service and Maintenance

User Protection

To avoid electrical shock do not dismantle the cover of the instrument. When any abnormal symptom happens with the instrument, please contact Associated Power Technologies or the authorized distributor for assistance.

Consistency of Service

The instrument's internal circuits and all related parts are required to be checked and calibrated at least once every year. This is to protect the user in terms of safety and to ensure a high accuracy of operation and measurement of this instrument at all times.

User Modification

Modification by the user of the instrument's internal circuits and all related parts is not recommended. All warranties will be void if any modifications have been conducted by the user. Associated Power Technologies reserves the right to convert the original circuitry to its original state if any modifications have been made to the instrument. The customer will be responsible for any charges associated with bringing the instrument to its original state.

11. Replacement Parts List

Part Number	Quantity	Ref Designator	Description
Supplied Accessories			
33189	1	-	8505 Input Power Cable
39534	1	-	Romex cable strain relief 1"
40291	2	-	Romex cable strain relief 1/2"
40257	1	-	Interlock Key
40280	2	-	2U Rack Mount Handle
40281	2	-	2U Rack Mount Bracket
40290	1	-	Protective Junction Box for Output Terminals (2U)
40338	1	-	Protective Junction Box for Output Terminals (8540)
40321	1	-	Protective Junction Box for Input Terminals
40328	1	-	Shorting Bar (4U)
40298	3	-	Shorting Bar (2U)
39066	1	-	USB Cable AB Type 1.8m
Panel Components			
40253	1	-	Display LCD 480 X 272
40265	1	-	Grey Dust Cover
38102	2	-	Rubber inserts for front legs
40001	1	-	Four piece plastic legs kit
40000	2	-	Rubber inserts for back legs
40319	1	-	Three-pole input terminal block
40296	1	-	Five-pole output terminal block
38339	2	-	Wire form fan guard
39629	1	-	Power button key top
40284	1	-	Top Cover
40285	1	-	Bottom Chassis (2U)
40334	1	-	Bottom Chassis (8540)
40286	1	-	Front Panel Mounting Bracket (2U)
40335	1	-	Front Panel Mounting Bracket (8540)
40339	1	-	8540 Front Panel Fan Cover
40283	1	-	Rear Panel (8505)
40320	1	-	Rear Panel (8512)
40322	1	-	Rear Panel (8520)
40336	1	-	Rear Panel (8540)
40292	1	-	Cover for GPIB Slot
40289	1	-	Tray for PLC board
40293	1	-	Main Front Panel
40294	1	-	Rotary Knob
40295	1	-	LCD Protective Panel
40279	1	-	Rubber Keypad
40327	7	-	Rubber pegs for 8540 front panel fan cover

Part Number	Quantity	Ref Designator	Description
PCB Assemblies			
40238	1	AMP8020	Main Amplifier Board Assembly PCB (8505)
40239	1	DDC8020	DC to DC Converter Board Assembly PCB (8505)
40245	1	AMP8020	Main Amplifier Board Assembly PCB (8512)
40248	1	DDC8020	DC to DC Converter Board Assembly PCB (8512)
40247	1	AMP8020	Main Amplifier Board Assembly PCB (8520)
40250	1	DDC8020	DC to DC Converter Board Assembly PCB (8520)
40246	2	AMP8020	Main Amplifier Board Assembly PCB (8540)
40249	2	DDC8020	DC to DC Converter Board Assembly PCB (8540)
40240	1	DSP8020	Digital Signal Processor Board Assembly PCB
40241	1	HOS8020	Host Board Assembly PCB
40242	1	KEY8020	Keyboard Board Assembly PCB
40243	1	MCU8020	MCU Board Assembly PCB
40244	1	PLC8020	Programmable Logic Control Board Assembly PCB
Internal Components			
40254	4	-	Fan 12VDC 80x80x25mm
40288	2	-	Fan bracket
40327	7	-	Rubber pegs for 8540 front panel fan cover