

**Model 72985**  
**SMB JACK STRAIGHT CRIMP, RG179, 187**

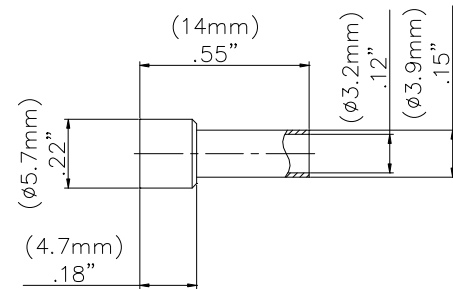

Model 72985 SMB JACK STRAIGHT CRIMP, RG179, 187

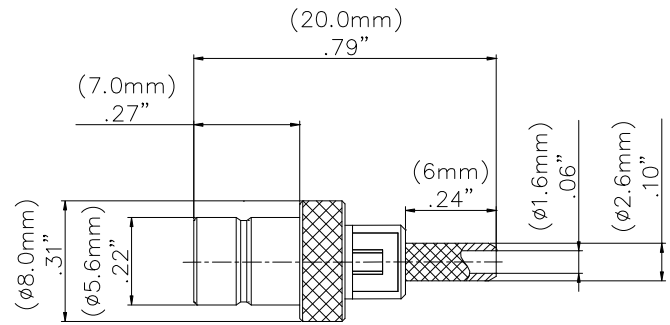

Snap-on coupling and small size for fast connect and disconnect.

**Features**

- DC - 3 GHz bandwidth.
- Meets MIL-C-39012, IEC 60169-1Q, BS9210N0007, NFC93650, CECC 22130.
- Small size and durability for RF coaxial applications.
- Precision machined and gold-plated for low loss.

**Materials**

- Body is machined brass with gold plating.
- Center contacts – Plug is gold plated brass and Jack is gold plated beryllium copper.
- High quality PTFE insulators.
- Crimp Ferrules are nickel plated copper.
- Silicone rubber gaskets.

**Ordering Information**

Model: 72985  
Description: SMB JACK STRAIGHT CRIMP, RG179, 187

**Specifications**

Impedance	75 Ω
Frequency Range	DC -3 GHz
VSWR	1.4 max.
Working Voltage	250 Vrms max.
Dielectric withstand voltage	750 Vrms
Center / Outer contact resistance	6 / 1 mΩ
Number of insertions	500 cycles min.
Insulation resistance	1,000 MΩ min.
Temperature Range	-65° C to 165° C, -85° F to 329° F

All dimensions are in inches. Tolerances (except noted): .xx = ±.02" (.51 mm), .xxx = ±.005" (.127 mm). All specifications are to the latest revisions. Specifications are subject to change without notice. Registered trademarks are the property of their respective companies.  
D2003425 REV 001

**Model 72985**  
**SMB JACK STRAIGHT CRIMP, RG179, 187**

**Cable Types and Crimp Die Information**

Connector Model #	Cable Groups	Crimp Die Cavity Size for Outer Ferrule
72985	RG179, 187	.128 (3.3)

**Cable Assembly Instructions**

1. CUT CABLE END EVENLY AND PERPENDICULAR

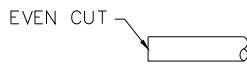

2. SLIDE OUTER FERRULE OVER CABLE END.

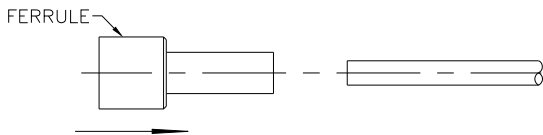

3. STRIP CABLE JACKET, BRAID, AND DIELECTRIC TO SPECIFICATION LENGTHS.

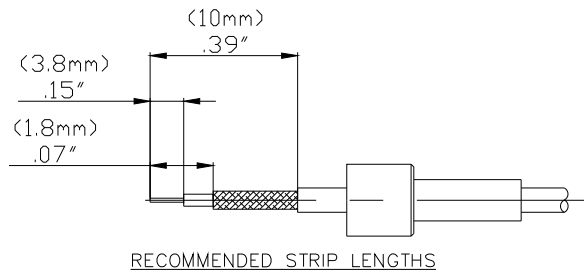

4. FLARE BRAID END SLIGHTLY.

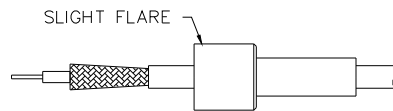

5. SLIDE CONNECTOR BODY OVER CENTER CONDUCTOR.

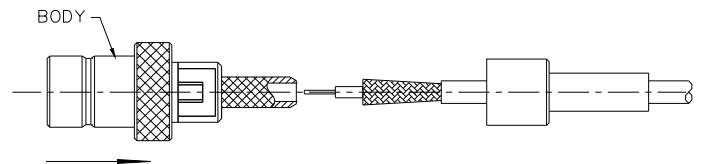

6. SLIDE OUTER FERRULE OVER BRAID AND UP AGAINST BODY ASSEMBLY.

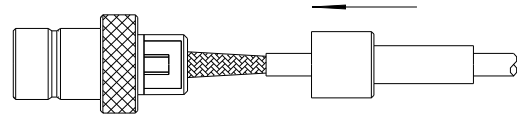

7. CRIMP OUTER FERRULE WITH APPROPRIATE CRIMP TOOL.

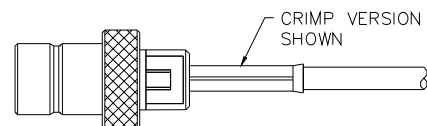

Distribuido Por:  
www.finaltest.com.mx  
Calle del Ebanó #16625  
Tijuana B.C. Mexico  
Tel. (664)681-1130  
Tel. 01800 027-4848  
ventas@final-test.net



All dimensions are in inches. Tolerances (except noted): .xx = ±.02" (.51 mm), .xxx = ±.005" (.127 mm). All specifications are to the latest revisions. Specifications are subject to change without notice. Registered trademarks are the property of their respective companies.  
D2003425 REV 001