

**Model 73006  
MCX PLUG R/A CRIMP, RG178**

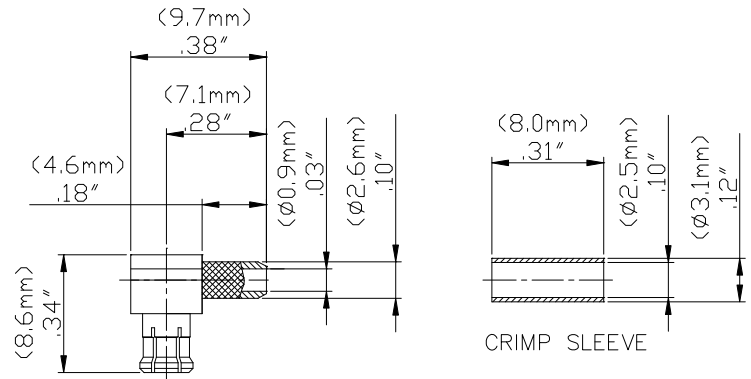

Model 73006 MCX PLUG R/A CRIMP, RG178

Snap-on coupling and miniature size for fast connect and disconnect where space is limited.

**Features**

- DC - 3 GHz bandwidth.
- 30% smaller than SMB connectors.
- Meets CECC 22220.
- Perfect for applications where space, weight, performance and ease of assembly are required.
- Precision machined and gold-plated for low loss.

**Materials**

- Body is machined brass with gold plating.
- Center contacts – Plug is gold plated brass and Jack is gold plated beryllium copper.
- High quality PTFE insulators.
- Crimp Ferrules are gold or nickel plated copper.

**Specifications**

Impedance	50 $\Omega$
Frequency Range	DC - 3 GHz
VSWR	1.4 max.
Working Voltage	170 Vrms max.
Dielectric withstand voltage	750 Vrms
Center / Outer contact resistance	5 / 2.5 m $\Omega$
Number of insertions	500 cycles min.
Insulation resistance	1,000 M $\Omega$ min.
Temperature Range	-55° C to 155° C, -67° F to 311° F

**Ordering Information**

Model: 73006  
Description: MCX PLUG R/A CRIMP, RG178

All dimensions are in inches. Tolerances (except noted): .xx =  $\pm .02$ " (.51 mm), .xxx =  $\pm .005$ " (.127 mm). All specifications are to the latest revisions. Specifications are subject to change without notice. Registered trademarks are the property of their respective companies.  
D2003443 REV 001

**Model 73006**  
**MCX PLUG R/A CRIMP, RG178**

**Cable Types and Crimp Die Information**

Connector Model #	Cable Groups	Crimp Die Cavity Size for Outer Ferrule
73006	RG 178	.105 (2.67)

**Cable Assembly Instructions**

1. CUT CABLE END EVENLY AND PERPENDICULAR.

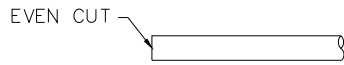

2. SLIDE OUTER FERRULE OVER CABLE END.

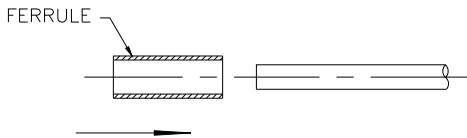

3. STRIP CABLE JACKET, BRAID, AND DIELECTRIC TO SPECIFICATION LENGTHS.

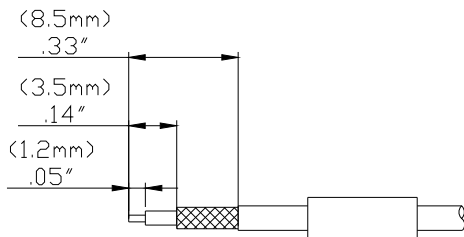

RECOMMENDED STRIP LENGTHS

4. SLIDE CONNECTOR BODY OVER CENTER CONDUCTOR, DIELECTRIC AND UNDER BRAID.

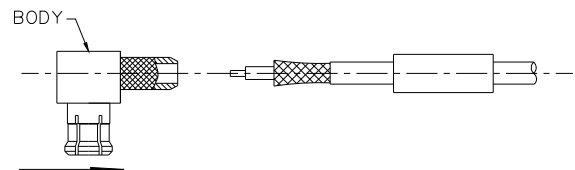

5. SLIDE OUTER FERRULE OVER BRAID AND UP AGAINST BODY ASSEMBLY.

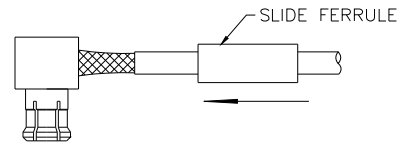

6. CRIMP OUTER FERRULE WITH APPROPRIATE CRIMP TOOL.

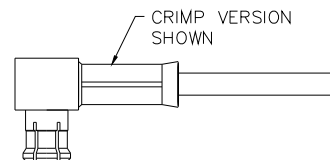

Distribuido Por:  
www.finaltest.com.mx  
Calle del Ebanó #16625  
Tijuana B.C. Mexico  
Tel. (664)681-1130  
Tel. 01800 027-4848  
ventas@final-test.net



All dimensions are in inches. Tolerances (except noted): .xx = ±.02" (.51 mm), .xxx = ±.005" (.127 mm). All specifications are to the latest revisions. Specifications are subject to change without notice. Registered trademarks are the property of their respective companies.  
D2003443 REV 001