

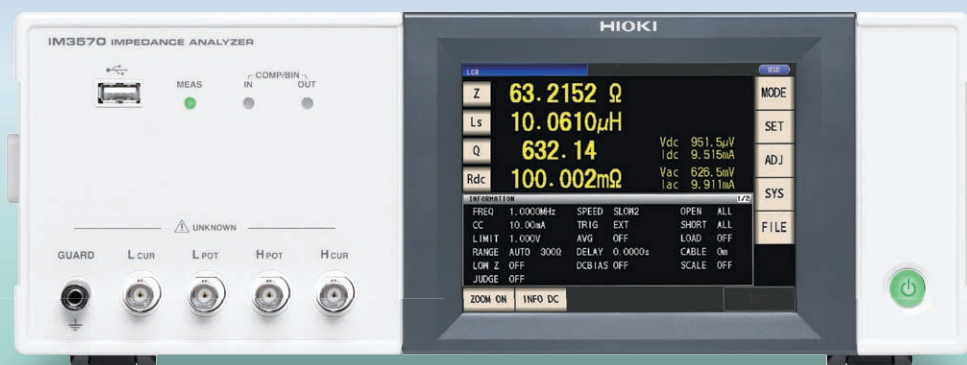

## IMPEDANCE ANALYZER IM3570

Component measuring instruments



## Single Device Solution for High Speed Testing and Frequency Sweeping

With this new **IM3570** Impedance Analyzer, an LCR meter and an impedance analyzer capable of measurement frequencies of 4 Hz to 5 MHz and test signal levels of 5 mV to 5 V have been combined into one measuring instrument. Advanced capabilities include LCR measurement with AC signals, resistance measurement with direct current (DCR), and sweep measurement which continuously changes the measurement frequency and measurement level.

The **IM3570** facilitates high-speed continuous measurement under different measurement conditions and measurement modes, so inspection lines which up to now have required multiple measuring instruments can be equipped with just one device.



ISO 9001  
JMI-0216



ISO 14001  
JQA-E-90091



[www.hioki.com](http://www.hioki.com)

HIOKI company overview, new products, environmental considerations and other information are available on our website.

LCR measurement, DCR measurement, and Sweep measurement

# Continuous Measurement and High-speed Testing Achieved with One Instrument

## IMPEDANCE ANALYZER IM3570



### Measurements recommended with IMPEDANCE ANALYZER IM3570

#### 1. Testing the resonance characteristics of piezoelectric elements

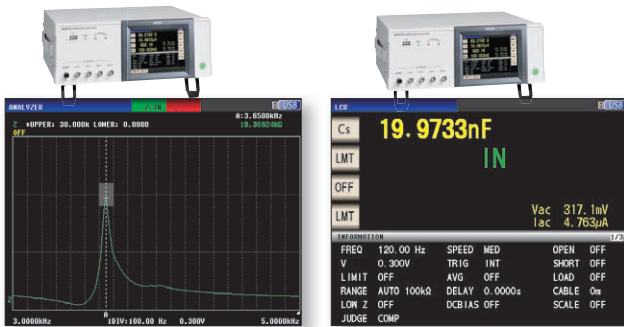

Frequency sweep measurement  
Z peak comparator screen

LCR mode  
Cs display screen (1 kHz measurement)

**Reduce Equipment Costs with Just 1 Device!**

Frequency sweep measurement can be used to measure the resonance frequency and its impedance, and then the peak comparator function can be used to make a pass/fail judgment on the resonance state.

In LCR mode, you can test capacitance by performing C measurement between 1 kHz and 120 Hz.



Continuous measurement screen



**High Speed and High Accuracy**

Frequency sweep measurement (impedance analyzer) and C measurement can be performed continuously with one instrument.

#### Advantage #1 -- Measurement time shortened

The measurement time has been shortened from previous models, achieving maximum speeds of 1.5ms\* (1 kHz) and 0.5ms\* (100kHz) in LCR mode. This is a significant increase in speed compared with previous Hioki products (3522-50 and 3532-50 with basic speed of 5ms). Faster speed contributes to an increase in test quantities. Furthermore, sweep measurement, which requires multiple points to be measured, realizes the quick speed of 0.3ms per point.

\* When the display is off (time increases by 0.3 ms when the display is on).

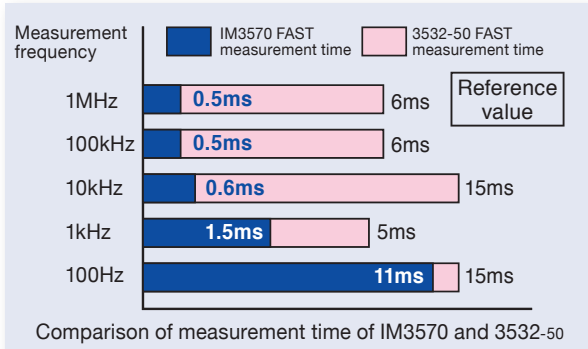

# Perfect Impedance Analyzer for Production Lines

## 2. C-D and low ESR measurement of functional polymer capacitors

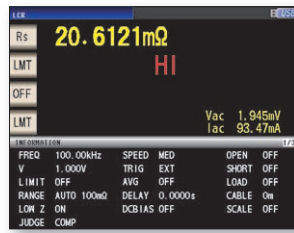

C-D (120 Hz) and low ESR (100 kHz) measurement can be performed for functional polymer capacitors.

Make continuous tests for different measurement items under different measurement conditions (frequency, level, and mode).

### Advantage #2 -- Low-impedance measurement accuracy improved

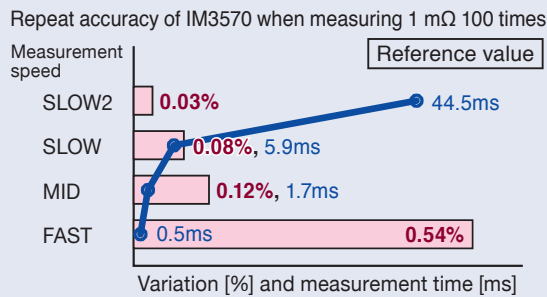

A one-digit improvement in repeat accuracy during low-impedance measurement has been achieved compared with previous Hioki products. For example, when the condition is 1 mΩ (1V, 100 kHz) and the measurement speed is MED, stable measurement with a repeat accuracy (variation)\* of 0.12% is possible, making this instrument suitable for 100 kHz ESR measurement.

\* Repeat accuracy (variation) is calculated based on the difference between the maximum and minimum values.

## 3. DCR and L-Q measurement of inductors (coils and transformers)

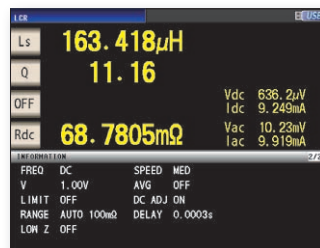
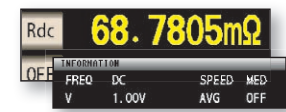
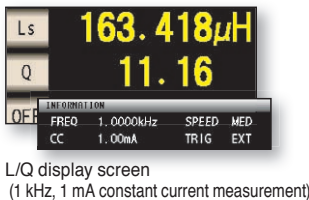

L/Q (1 kHz, 1 mA constant current measurement) and DCR (DC measurement) display screen

The instrument can continuously measure L-Q (1 kHz, 1mA constant current) and DCR, and display the numerical values on the same screen. Current dependent elements such as coils incorporating cores for which the inductance value varies depending on the applied current can be measured with a constant current (CC). Since there is a one-digit improvement in repeat accuracy during low impedance measurement compared with previous products, stable measurement of DCR can be expected.

### Advantage #3

By improving the measurement accuracy of  $\theta$  compared with previous Hioki products, measurement with an absolute accuracy and repeat accuracy of one-digit better than before can be performed for high Q and Rs values for which  $\theta$  is in the vicinity of 90°.

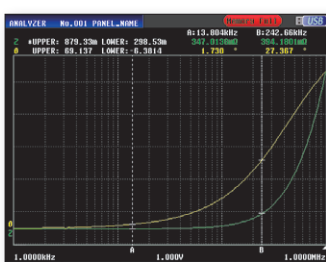

Frequency sweep measurement Z-θ measurement screen

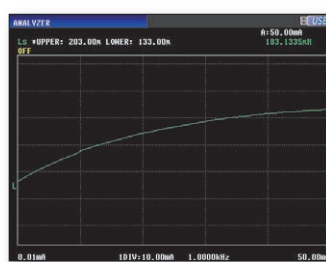

CC value sweep measurement Ls measurement screen

The measurement frequency of a coil differs depending on the application. The wide measurement range of 4 Hz to 5 MHz facilitates the measurement of various coils.

Constant current sweep measurement enables a current characteristic graph to be displayed for current dependent elements.

# Test Efficiency Improved by High-speed and High-accuracy Measurements

## ■ Features of IM3570

### ● Low-capacitance (high-impedance) measurement with improved stability

There is a one-digit improvement in repeat accuracy during low-capacitance (high-impedance) measurement compared with previous Hioki products. For example, when the condition is 1 pF (1 MHz, 1 V) and the measurement speed is SLOW2, stable measurement with a repeat accuracy (variation)\* of 0.01% is possible.

At the same time, phase repeat accuracy is also improved, which in turn has improved the stability of D measurement during low-capacitance (high-impedance) measurement.

\* Repeat accuracy (variation) is calculated based on the difference between the maximum and minimum values.

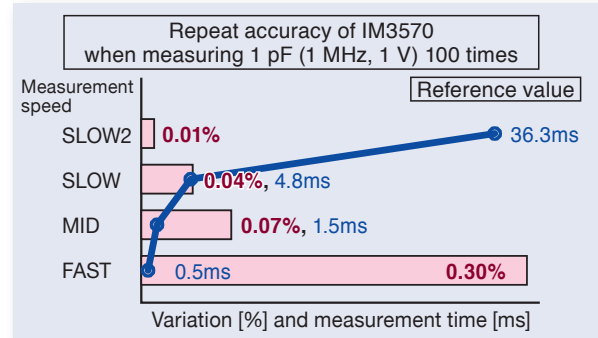

### ● Wide setting range for measurement frequency

IM3570 allows DC or a frequency band within the range of 4 Hz to 5 MHz to be set with five-digit resolution (testing at less than 1 KHz has a 0.01 Hz resolution). This enables the measurement of resonance frequency and measurement and evaluation in a state close to that of actual operating conditions.

### ● 15 parameters measured

The following parameters can be measured and selected parameters can be captured by a computer: Z, Y,  $\theta$ , Rs (ESR), Rp, Rdc (DC resistance), X, G, B, Ls, Lp, Cs, Cp, D (tan $\delta$ ), and Q.

### ● Incorporates contact check function (open-circuit check)

The contact check function for four-terminal measurement (only for low impedance high accuracy mode) and two-terminal measurement prevents measurement in a state in which a measurement electrode is not in contact with the measurement object.

### ● Comparator and BIN functions

In LCR mode, the instrument allows for Hi, IN, and Lo judgments of two types from the measurement items on one screen. For the judgment method, % setting and  $\Delta\%$  setting are available in addition to absolute value setting. If continuous measurement is used, judgments which span over multiple measurement conditions and measurement items are possible. The BIN function can be used to classify two types of measurement items on one screen into 10 categories and out of range. In analyzer mode, the peak comparator for judging whether resonance points pass or fail can be used.

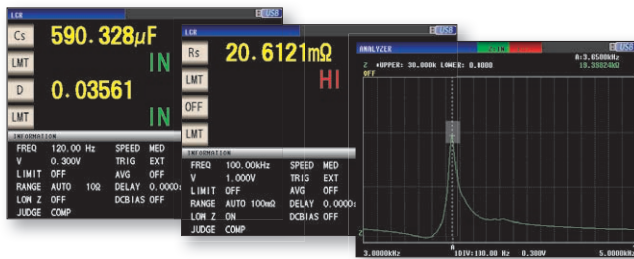

### ● Segment setting

Up to 20 segments with a total of up to 801 points can be set for the sweep range. This is effective for evaluating multiple frequency ranges in detail.

### ● Memory function

Up to 32,000 measurement results can be stored in the memory of the instrument. The saved measurement results can be copied to a USB flash drive, and can also be acquired using a communication command.

### ● Wide setting range for measurement voltage and current

In addition to normal open-loop signal generation, this instrument enables measurement considering voltage/current dependence in constant voltage and constant current modes. The signal levels can be set over wide ranges, from 5 mV to 5 V, and from 10  $\mu$ A to 50 mA (up to 1 MHz). (The setting range of measurement signal levels differs depending on the frequency and measurement mode.)

### ● DC bias can be generated internally

Up to a 2.5 V DC bias can be applied and then measurement performed with just the unit. This is reassuring when measuring polar capacitors such as a tantalum capacitor. The charge impedance is 100  $\Omega$ . (The DC bias unit required with 3522-50 and 3532-50 is not needed for IM3570 within the bias voltage range of 0 to +2.5V. If a larger bias voltage is required, an external option, which is scheduled to be released in the future, is required.)

### ● High resolution with up to 7-digit display

High-resolution measurement with full 7-digit display is possible. The number of display digits can be set from 3 to 7.

### ● Four-terminal probe allows for use at DC to 5 MHz

The L2000 4-terminal probe (option) employs a 4-terminal structure to facilitate 50  $\Omega$  characteristic impedance and improved measurement accuracy, and is well suited to the IM3570.

### ● Measurement cable extendable to up to 4 meters

Accuracy is guaranteed at the measurement cable lengths of 0, 1, 2, and 4 meters. This makes wiring automated machinery simple. (The frequency range for which accuracy is guaranteed differs depending on the cable length. The probe needs to be provided by the customer.)

### ● Longer stability

Measurement accuracy is guaranteed for one year. Previous models required calibration every 6 months, but with this model the calibration interval has been extended to one year.

### ● Interval measurement

In order to, for example, confirm the temporal changes of an element from the response of a sensor, parameter time variations can be measured for up to 801 points at a specified interval (100  $\mu$ s to 10,000s), and then the data can be displayed in a graph or list.

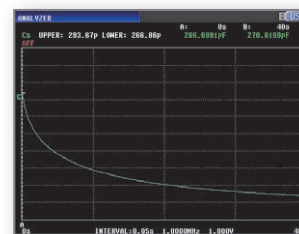

Interval setting screen

# Link with computer via USB, LAN, RS-232C, or GP-IB Effective for Acquisition and Analysis of Measurement Data

## ● PC application

Basic software capable of frequency characteristics, level characteristics, and continuous measurement is provided. Connecting a PC to the RS-232C, USB, or LAN port on the rear panel enables you to easily operate the instrument from the PC and acquire data. The software includes simple command send functions that can be used to save effort in the measurement sequence and confirm interface command operations.

## ● Instrument mode indicators

Indicators allow you to identify the operating state of the instrument even when the LCD display is off.

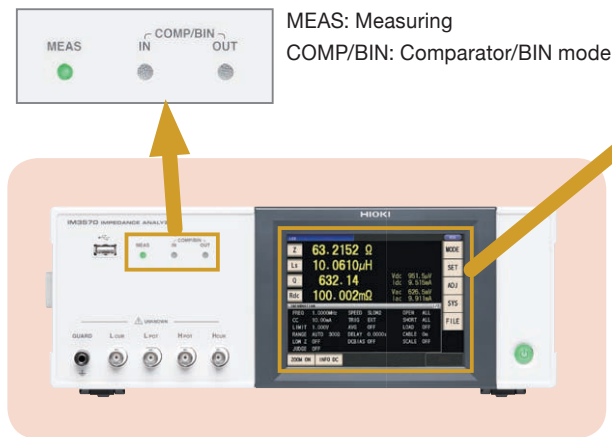

No.	FREQUENCY	L	R	C	D
1	1.000E+01	2.53400E-05	1.72679E-02		
2	1.000E+01	2.53410E-05	1.72684E-02		
3	1.100E+01	2.82689E-05	1.72737E-02		
4	1.200E+01	2.84440E-05	1.72790E-02		
5	1.300E+01	2.86200E-05	1.72843E-02		
6	1.380E+01	2.88010E-05	1.72896E-02		
7	1.460E+01	2.89820E-05	1.72949E-02		
8	1.540E+01	2.91640E-05	1.73002E-02		
9	1.620E+01	2.93460E-05	1.73055E-02		

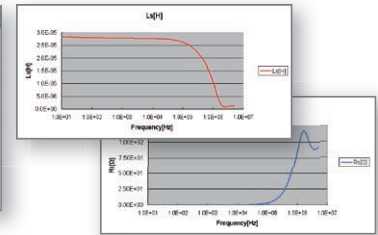

## ● Intuitive operation with touch panel

A touch panel display with intuitive operation is inherited from previous models. Furthermore, the incorporation of a color LCD means the display is easy to view, and outstanding operability which ensures you intuitively know what to do helps improve work efficiency.



Measurement conditions such as the measurement frequency and measurement signal level can be changed while you monitor the measurement values.

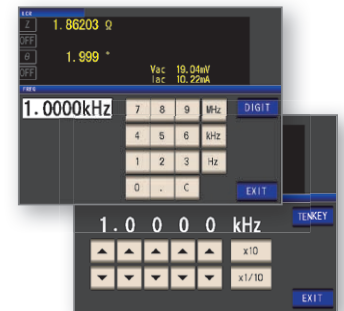

## ■ Saving and reading data via front-loading USB port

Measurement results and settings can be saved to a commercially available USB flash drive connected to the front panel.

(The USB port on the front panel is specifically for a USB flash drive. Batch save all measurement results to a USB flash drive after saving them to the internal memory of IM3570. Some USB flash drives may not be able to be used due to incompatibility issues.)

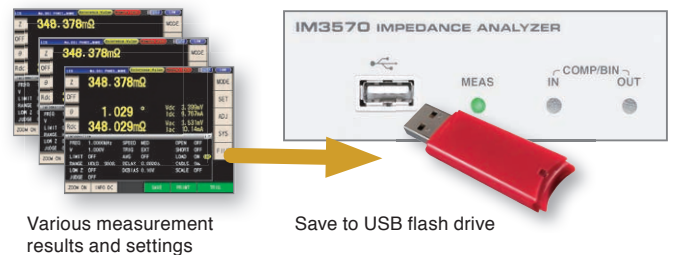

## ■ External control from PC or PLC via USB, LAN, GP-IB, or RS-232C connection

The rear panel is standard equipped with RS-232C, GP-IB, USB and LAN ports. (The USB port on the rear panel is specifically for connecting a PC.)

Various functions of IM3570 can be controlled from a PLC or PC, and measurement results can be acquired. (Excluding turning the power on/off and configuring some interface settings.)

Use of an interface suitable for automated machinery enables you to build the optimal measurement system.

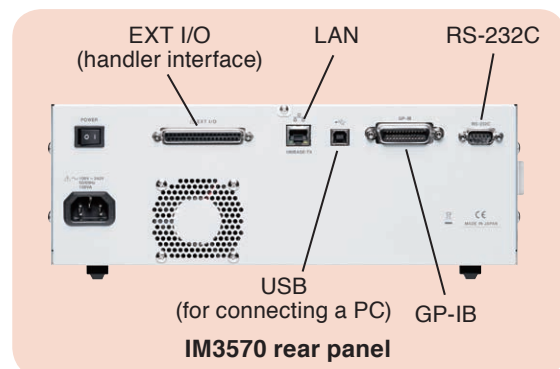

## EXT I/O

### Handler (EXT I/O) interface

The handler (EXT I/O) interface enables output of an end of measurement signal and measurement result signal, and input of signals such as a measurement trigger signal to control the measuring instrument. Each of the signal lines is isolated from the control circuit, and the structure is designed to protect against noise.

#### Example of representative EXT I/O timing

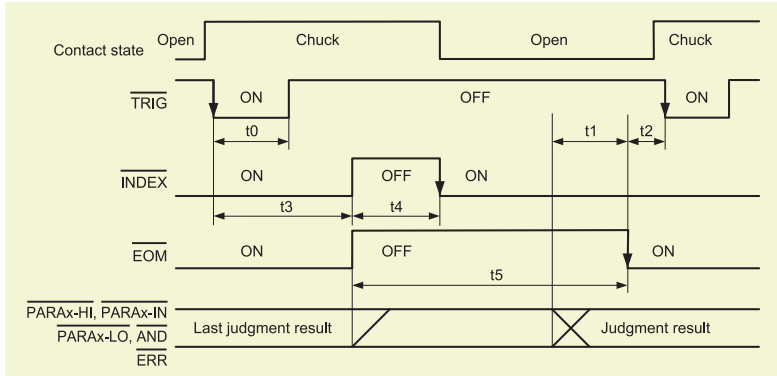

- t0: Minimum time for trigger signal: 0.3 ms or longer \*1
- t1: Delay setting time from comparator and BIN judgment results to  $\overline{\text{EOM}}$  (LOW): 0.04 ms or longer \*1
- t2: Minimum time from end of measurement to next trigger: 0.4 ms \*1
- t3: Time from trigger to response by circuit: 0.7 ms \*1
- t4: Minimum chuck time for which chuck can be switched with  $\overline{\text{INDEX}}$  (LOW): 0.3 ms \*1
- t5: Measurement time: 0.5 ms \*1

\*1: When the measurement speed is FAST and the range is HOLD.

#### Connectors

Connectors to use (unit side) : 37-pin D-SUB female connector with #4-40 inch screws

Compliant connectors : DC-37P-ULR (solder type) and DCSP-JB37PR (insulation-displacement type)  
For information on where to obtain connectors, consult your nearest HIOKI distributor.

## IM3570 specifications

<b>Measurement modes</b>	LCR mode: Measurement with single condition Analyzer mode: Sweeps with measurement frequency and measurement level (Measurement points: 1 to 801, Measurement method: normal sweep or segment sweep, Display: List display or graph display) Continuous measurement mode: Measures under saved conditions continuously (maximum of 32 sets)	<b>Output impedance</b>	Normal mode: 100 Ω Low impedance high accuracy mode: 10 Ω
<b>Measurement parameters</b>	Z Impedance Y Admittance θ Phase angle Rs(ESR) Series-equivalent resistance = ESR Rp Parallel-equivalent resistance Rdc DC resistance X Reactance G Conductance B Susceptance Cs Series-equivalent static capacitance Cp Parallel-equivalent static capacitance Ls Series-equivalent inductance Lp Parallel-equivalent inductance D(tanδ) Loss coefficient = tan δ (δ= delta) Q Q factor (Q = 1/D)	<b>Display</b>	5.7-inch color TFT, display can be set to ON/OFF
<b>Measurement range</b>	100 mΩ to 100 MΩ, 12 ranges (All parameters are determined according to Z)	<b>No. of display digits setting</b>	The number of display digits can be set from 3 to 7 (initial value: 6 digits)
<b>Display range</b>	Z, Y, Rs, Rp, Rdc, X, G, B, Ls, Lp, Cs, Cp : ±(0.000000 [unit] to 9.999999 [unit]) Absolute value display for Z and Y only θ : ±(0.000° to 999.999°) D : ±(0.000000 to 9.999999) Q : ±(0.00 to 99999.99) Δ % : ±(0.0000% to 999.9999%)	<b>Measurement time</b>	0.5 ms (100 kHz, FAST, display OFF, representative value)
<b>Basic accuracy</b>	Z : ±0.08%rdg. θ: ±0.05°	<b>Measurement speed</b>	FAST/MED/SLOW/SLOW2
<b>Measurement frequency</b>	4Hz to 5MHz (10 mHz to 100 Hz steps)	<b>DC bias measurement</b>	Normal mode: 0 VDC to 2.50 VDC (10 mV steps) Low impedance high accuracy mode: 0 VDC to 1.00 VDC (10 mV steps)
<b>Measurement signal level</b>	Normal mode: V mode/CV mode: 5 mV to 5 Vrms (up to 1 MHz), 10 mV to 1 Vrms (1 MHz to 5 MHz), 1 mVrms steps CC mode: 10 μA to 50 mArms (up to 1 MHz), 10 μA to 10 mArms (1 MHz to 5 MHz), 10 μArms steps Low impedance high accuracy mode: V mode/CV mode: 5 mV to 1 Vrms (up to 100 kHz), 1 mVrms steps CC mode: 10 μA to 100 mArms (100 mΩ and 1 Ω ranges of up to 100 kHz), 10 μArms steps	<b>DC resistance measurement</b>	Normal mode Measurement signal level: 100 mVDC to 2.5 VDC (10 mV steps) Low impedance high accuracy mode Measurement signal level: 100 mVDC to 1.00 VDC (10 mV steps)
		<b>Comparator</b>	LCR mode: Hi/IN/Lo for first and third items Analyzer mode: Area judgment (Hi/IN/Lo for each point) Peak judgment (Hi/IN/Lo for local maximum and local minimum frequency and absolute values)
		<b>BIN measurement</b>	10 classifications and out of range for 2 items
		<b>Compensation</b>	Open/short/load/cable length of 0 and 1 m/correlation compensation
		<b>Residual charge protection function</b>	$V = \sqrt{10/C}$ (C: Capacitance [F] of test sample, V = max. 400 V)
		<b>Trigger synchronous output function</b>	Applies a measurement signal during analog measurement only
		<b>Averaging</b>	1 to 256
		<b>Interval measurement</b>	100 μs to 10,000 s, max. 801 points
		<b>Panel loading/saving</b>	LCR mode: 30; Analyzer mode: 2; Compensation value: 128
		<b>Memory function</b>	Stores 32,000 data items to the memory of the instrument
		<b>Printer</b>	Prints measurement values and graphs (9670 option, etc. required)
		<b>Interfaces</b>	EXT I/O (handler), RS-232C, GP-IB, USB (Hi-Speed/Full-Speed), USB flash drive, LAN (10BASE-T/100BASE-TX)
		<b>Operating temperature and humidity ranges</b>	0°C to 40°C, 80% RH or less, no condensation
		<b>Storage temperature and humidity ranges</b>	-10°C to 50°C, 80% RH or less, no condensation
		<b>Power supply</b>	90 to 264 V AC, 50/60 Hz, 150 VA max.
		<b>Dimensions and weight</b>	Approx. 330 (W) × 119 (H) × 307 (D), approx. 5.8 kg
		<b>Accessory</b>	Power cord × 1

# IM3570 measurement accuracy

## Conditions

Temperature and humidity ranges: 23°C ± 5°C, 80% RH or less (no condensation), at least 60 minutes after power turned on, after performing open and short compensation

**Basic accuracy (Z, θ) calculation expression**

In the 1 kΩ range and above and 300 Ω range and below, the calculation expression of basic accuracy differs as shown below. For details, refer to the following calculation examples.

Top A: Basic accuracy of Z (± % rdg.)  
B is the coefficient for the impedance of the sample

1 kΩ range and above:  
Accuracy =  $A + B \times \left| \frac{10 \times Z_x}{\text{Range}} - 1 \right|$

Bottom A: Basic accuracy of θ (± % deg.)  
B is the coefficient for the impedance of the sample

300 Ω range and below:  
Accuracy =  $A + B \times \left| \frac{\text{Range}}{Z_x} - 1 \right|$

A is the accuracy of R when DC (± % rdg.)  
B is the coefficient for the resistance of the sample

Z<sub>x</sub> is the actual impedance measurement value (Z) of the sample.

The measurement accuracy is calculated based on the following equation.  
**Measurement accuracy = Basic accuracy × C × D × E × F × G**

- [C: Level coefficient] V: Setting value (corresponds to when V mode) [V]  
 0.005V to 0.999V :  $1 + \frac{0.1}{V}$  (For measurements other than DCR, at 30kΩ range or below)  
 $1 + \frac{0.3}{V}$  (All DCR ranges, and 100kΩ range and above for measurements other than DCR)
- 1V to 5V : 1
- [D: Measurement speed coefficient]  
 FAST : 8, MED : 4, SLOW : 2, SLOW2 : 1
- [E: Measurement cable length coefficient] f<sub>m</sub>: Measurement frequency [kHz]  
 0 m : 1 (DC to 5MHz), 1 m : 1.5 (DC to 5MHz),  
 2 m :  $2 \times \left(1 + \frac{f_m}{100}\right)$  (DC to 100kHz), 4 m :  $4 \times \left(1 + \frac{f_m}{100}\right)$  (DC to 10kHz)
- [F: DC bias coefficient] V<sub>AC</sub>: AC signal voltage setting value [V]  
 DC bias setting OFF : 1  
 DC bias setting ON :  $2 \times \left(1 + \frac{0.1}{V_{AC}}\right), 4 \times \left(1 + \frac{0.1}{V_{AC}}\right)$  (At 10Ω range or below, minimum 100.01 kHz.)
- [G: Temperature coefficient] t: Operating temperature  
 When t is 18°C to 28°C : 1, When t is 0°C to 18°C or 28°C to 40°C :  $1 + 0.1 \times |t - 23|$

## Basic accuracy

Range	Guaranteed accuracy range	DC	4 Hz to 99.9 Hz	100 Hz to 999.99 Hz	1 kHz to 10 kHz	10.01 kHz to 100 kHz	100.1 kHz to 1 MHz	1.001 MHz to 5 MHz
100MΩ	8MΩ to 200MΩ	A=4 B=6	A=6 B=5 A=5 B=3	A=3 B=2 A=2 B=2	A=3 B=2 A=2 B=2	A=8 B=4 A=3 B=2		* Set the accuracy to $\frac{(f[\text{MHz}] + 3)}{4}$ times for 1.001 MHz or above.
10MΩ	800kΩ to 100MΩ	A=0.5 B=0.3	A=0.8 B=1 A=0.8 B=0.5	A=0.5 B=0.3 A=0.4 B=0.2	A=0.5 B=0.3 A=0.4 B=0.2	A=1 B=0.7 A=1 B=0.2	A=3 B=2 A=3 B=1	
1MΩ	80kΩ to 10MΩ	A=0.2 B=0.1	A=0.4 B=0.08 A=0.3 B=0.08	A=0.3 B=0.05 A=0.2 B=0.02	A=0.3 B=0.05 A=0.2 B=0.02	A=0.3 B=0.08 A=0.3 B=0.08	A=1 B=0.5 A=1 B=0.5	* A=2 B=1 A=2 B=1
100kΩ	24kΩ to 1MΩ	A=0.1 B=0.01	A=0.3 B=0.01 A=0.3 B=0.01	A=0.2 B=0.01 A=0.1 B=0.01	A=0.15 B=0.01 A=0.1 B=0.01	A=0.25 B=0.04 A=0.2 B=0.02	A=0.4 B=0.3 A=0.3 B=0.3	* A=2 B=0.5 A=2 B=0.3
30kΩ	8kΩ to 300kΩ	A=0.1 B=0.01	A=0.3 B=0.01 A=0.3 B=0.01	A=0.2 B=0.005 A=0.1 B=0.003	A=0.12 B=0.005 A=0.08 B=0.003	A=0.25 B=0.01 A=0.15 B=0.005	A=0.4 B=0.05 A=0.3 B=0.03	* A=2 B=0.1 A=2 B=0.1
10kΩ	2.4kΩ to 100kΩ	A=0.1 B=0.01	A=0.3 B=0.01 A=0.3 B=0.01	A=0.2 B=0.01 A=0.1 B=0.005	A=0.12 B=0.005 A=0.08 B=0.002	A=0.2 B=0.02 A=0.08 B=0.02	A=0.3 B=0.03 A=0.2 B=0.05	* A=1.5 B=0.2 A=1 B=0.2
3kΩ	800Ω to 30kΩ	A=0.1 B=0.01	A=0.3 B=0.02 A=0.2 B=0.01	A=0.2 B=0.005 A=0.1 B=0.002	A=0.12 B=0.005 A=0.08 B=0.002	A=0.2 B=0.005 A=0.08 B=0.005	A=0.3 B=0.01 A=0.15 B=0.01	* A=1.5 B=0.02 A=1 B=0.03
1kΩ	240Ω to 10kΩ	A=0.1 B=0.01	A=0.3 B=0.02 A=0.2 B=0.01	A=0.2 B=0.01 A=0.1 B=0.005	A=0.1 B=0.005 A=0.08 B=0.002	A=0.2 B=0.01 A=0.08 B=0.01	A=0.3 B=0.01 A=0.15 B=0.01	* A=1.5 B=0.01 A=1 B=0.01
300Ω	8Ω to 300Ω	A=0.1 B=0.02	A=0.4 B=0.02 A=0.2 B=0.01	A=0.3 B=0.02 A=0.15 B=0.01	A=0.08 B=0.02 A=0.05 B=0.01	A=0.2 B=0.02 A=0.08 B=0.02	A=0.3 B=0.03 A=0.15 B=0.02	* A=1.5 B=0.05 A=1 B=0.05
10Ω	800mΩ to 10Ω	A=0.2 B=0.15	A=0.5 B=0.2 A=0.3 B=0.1	A=0.4 B=0.05 A=0.3 B=0.03	A=0.3 B=0.05 A=0.15 B=0.03	A=0.3 B=0.05 A=0.15 B=0.03	A=0.4 B=0.2 A=0.3 B=0.1	* A=2 B=1.5 A=2 B=1
1Ω	80mΩ to 1Ω	A=0.3 B=0.3	A=2 B=1 A=1 B=0.6	A=0.6 B=0.3 A=0.5 B=0.2	A=0.4 B=0.3 A=0.25 B=0.2	A=0.4 B=0.3 A=0.25 B=0.2	A=1 B=1 A=0.7 B=0.5	* A=3 B=3 A=3 B=2
100mΩ	1mΩ to 100mΩ	A=3 B=2	A=10 B=10 A=6 B=6	A=3 B=3 A=2 B=2	A=3 B=3 A=2 B=1.5	A=2 B=2 A=2 B=1.5	A=4 B=3 A=3 B=4	

### Method of determining basic accuracy

- Calculate the basic accuracy from the sample impedance, measurement range, and measurement frequency and the corresponding basic accuracy A and coefficient B from the table above.
- The calculation expression to use differs for each of the 1 kΩ range and above and 300 Ω range and below.
- For C and L, obtain basic accuracy A and coefficient B by determining the measurement range from the actual measurement value of impedance or the approximate impedance value calculated with the following expression.

$$Z_x(\Omega) \doteq \omega L(\text{H}) \quad (\theta \doteq 90^\circ)$$

$$\doteq \frac{1}{\omega C(\text{F})} \quad (\theta \doteq -90^\circ)$$

$$\doteq R(\Omega) \quad (\theta \doteq 0^\circ) \quad (\omega: 2 \times \pi \times \text{Measurement frequency [Hz]})$$

### Calculation example

Impedance Z<sub>x</sub> of sample: 500 Ω (actual measurement value)  
 Measurement conditions: When frequency 10 kHz and range 1 kΩ

Insert coefficient A = 0.1 and coefficient B = 0.005 for the Z basic accuracy from the table above into the expression.

$$Z \text{ basic accuracy} = 0.1 + 0.005 \times \left| \frac{10 \times 500}{10^3} - 1 \right| = 0.12 (\pm \% \text{rdg.})$$

Similarly, insert coefficient A = 0.08 and coefficient B = 0.002 for the θ basic accuracy, as follows:

$$\theta \text{ basic accuracy} = 0.08 + 0.002 \times \left| \frac{10 \times 500}{10^3} - 1 \right| = 0.088 (\pm \% \text{deg.})$$

## Guaranteed accuracy range (measurement signal level)

The guaranteed accuracy range differs depending on the measurement frequency, measurement signal level, and measurement range.

Range	DC	4 Hz to 99.9 Hz	100 Hz to 999.99 Hz	1 kHz to 10 kHz	10.01 kHz to 100 kHz	100.1 kHz to 1 MHz	1.001 MHz to 5 MHz	
100MΩ	1 V to 2.5 V		0.101 V to 5 V		0.501 V to 5 V			
10MΩ	0.1 V to 2.5 V		0.050 V to 5 V		0.101 V to 5 V	0.501 V to 5 V		
1MΩ					0.050 V to 5 V	0.101 V to 5 V	0.501 V to 1 V	
100kΩ						0.050 V to 5 V	0.101 V to 1 V	
30kΩ, 10kΩ, 3kΩ, 1kΩ, 300Ω, 10Ω				0.005 V to 5 V				0.050 V to 1 V
1Ω				0.005 V to 5 V <sup>*2</sup>		0.101 V to 5 V	0.501 V to 1 V	
100mΩ	0.1 V to 2.5 V <sup>*1</sup>		0.101 V to 5 V <sup>*3</sup>		0.501 V to 5 V <sup>*3</sup>			

The above voltages are the voltage setting values correspond to when in V mode.

\*1 Guaranteed accuracy of 10 mΩ or above, \*2 Guaranteed accuracy of 0.101 V to 5 V when DC bias, \*3 Guaranteed accuracy of 10 mΩ or above and 1.001 V to 5 V when DC bias

## OPTION

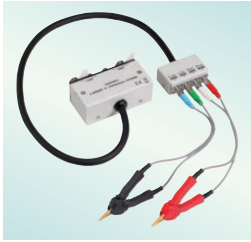

**FOUR-TERMINAL PROBE L2000**  
DC to 5 MHz  
Characteristic impedance: 50 Ω  
4-terminal structure  
Test sample dimensions: 5mm or less  
\* The cable length is 1 m.



**TEST FIXTURE 9262**  
DC to 5 MHz



**SMD TEST FIXTURE 9263**  
DC to 5 MHz  
Test sample dimensions:  
1 mm (0.04 in) to 10 mm (0.39 in)



**SMD TEST FIXTURE 9677**  
Electrodes on side for SMD  
DC to 120 MHz  
Test sample dimensions:  
3.5mm ±0.5mm (0.14in ±0.02in)



**SMD TEST FIXTURE 9699**  
Electrodes on bottom for SMD  
DC to 120 MHz  
Test sample dimensions: 1.0mm (0.04in) to 4.0mm (0.16in) wide, maximum 1.5mm (0.06in) high

### ● Printer 9670



Print method	Thermal line dot
Print width	72 mm
Print speed	47.5 mm/s
Power	AC Adapter 9671 or Battery Pack 9672
Dimensions	Approx. 119 × 77 × 174 mm
Mass	Approx. 500 g

Printer operation requires RS-232C Cable 9638 and AC Adapter 9671, and battery operation requires Battery Pack 9672 and Battery Charger 9673.

#### Print Example

```
Z 1.85223 ohm IN
PH 2.011 deg HI
```

```
Z 1.84557 ohm
OFF
PH 2.024 deg
OFF
```

```
Z 350.732mΩ
OFF
θ 0.416 °
OFF
Vac 3.5
Iac 10.0
```

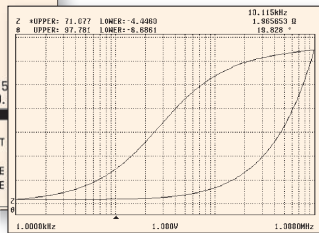

### Other High Performance HIOKI LCR Meters



**LCR HiTESTER 3522-50**  
(DC, 1mHz to 100kHz)

**LCR HiTESTER 3532-50**  
(42Hz to 5MHz)

- Basic accuracy: Z; ± 0.08%
- Fastest measurement time 5 ms
- Built-in comparator: Upper and lower limit, absolute value

- Higher frequency range: DC, 1mHz to 100kHz (3522-50) / 42Hz to 5MHz (3532-50)
- Fourteen parameters measured: |Z|, |Y|, θ, Rp(DCR\*), Rs(ESR, DCR\*), G, X, B, Cp, Cs, Lp, Ls, D(tan δ), Q (\*3522-50 only)
- Interactive touch panel operation, Simultaneous setting and measurement
- Enlarged display function
- Printer output (with the optional PRINTER 9442)

## IMPEDANCE ANALYZER IM3570

(Standard accessories: power cord)

**Test fixtures are not supplied with the unit.  
Select an optional test fixture or probe when ordering.**

### ■ Optional accessories

FOUR-TERMINAL PROBE L2000 (1m)  
TEST FIXTURE 9262 (direct connection type)  
SMD TEST FIXTURE 9263 (direct connection type)  
SMD TEST FIXTURE 9677 (direct connection type)  
SMD TEST FIXTURE 9699 (direct connection type,  
For measuring SMDs with electrodes on the bottom)

GP-IB CONNECTION CABLE 9151-02 (2 m/78.74")  
PRINTER 9670 (Non CE)  
AC ADAPTER 9671 (AC100 to 240V, Non CE)  
RS-232C CABLE 9638 (25 pin-9 pin, 1.5m, for 9670 connectors)  
RECORDING PAPER 9237 (80 mm × 25 mm, 4 rolls)

Note: Company names and Product names appearing in this catalog are trademarks or registered trademarks of various companies.

**HIOKI**  
HIOKI E. E. CORPORATION

**HEAD OFFICE :**  
81 Koizumi, Ueda, Nagano, 386-1192, Japan  
TEL +81-268-28-0562 / FAX +81-268-28-0568  
http://www.hioki.co.jp / E-mail: os-com@hioki.co.jp

**HIOKI USA CORPORATION :**  
6 Corporate Drive, Cranbury, NJ 08512 USA  
TEL +1-609-409-9109 / FAX +1-609-409-9108  
http://www.hiokiusa.com / E-mail: hioki@hiokiusa.com

**HIOKI (Shanghai) Sales & Trading Co., Ltd. :**  
1608-1610 Shanghai Times Square Office, 93 Huai Hai Zhong Road,  
Shanghai, P.R.China POSTCODE: 200021  
TEL +86-21-6391-0090/0092 FAX +86-21-6391-0360  
http://www.hioki.cn / E-mail: info-sh@hioki.com.cn  
**Beijing Office :**  
TEL +86-10-5867-4080/4081 FAX +86-10-5867-4090  
E-mail: info-bj@hioki.com.cn  
**Guangzhou Office :**  
TEL +86-20-38392673/2676 FAX +86-20-38392679  
E-mail: info-gz@hioki.com.cn  
**HIOKI INDIA PRIVATE LIMITED :**  
Khandela House, 24 Gulmohar Colony Indore 452 018 (M.P.), India  
TEL +91-731-4223901, 4223902 FAX +91-731-4223903  
http://www.hioki.in / E-mail: info@hioki.in

DISTRIBUTED BY

**FINAL TEST**  
Venta de Instrumentos de Prueba y Medición

www.finaltest.com.mx  
Calle del Ebano #16625  
Tijuana B.C. Mexico  
Tel. (664)681-1130  
Tel. 01800 027-4848  
ventas@final-test.net